

RESSORTS DE COMPRESSION

Les ressorts de compression SPEC offrent aux Ingénieurs des Bureaux d'Etudes, aux Dessinateurs, et aux Services de Production et de Maintenance, des ressorts de précision économiques et efficaces. Le service SPEC permet de réaliser des économies de temps et donc d'argent, les calculs et dessins n'étant plus nécessaires.

MATÉRIAUX

Références commençant par 'C'

Corde à piano suivant DIN 17223, Classe C. No. 1,1200. - BS5216 ND3 ou HD3 - AMS 5112.

Fil en acier inoxydable suivant DIN 17224, No. 1,4310, BS2056 EN58A. Commercial 302 AMS 5688 acier trempé pour ressorts.

Références commençant par 'D'

Corde à Piano suivant DIN 17223 ou JIS G4314 SWP-A/B ou AMS 5112.

Fil en acier inoxydable type 301, 302 ou 304 suivant DIN 17224 ou JIS G4314 SUS 302/304 ou AMS 5688 acier trempé pour ressorts.

TOLÉRANCES

Références commençant par 'C'

Do=Diamètre extérieur	
1.45 à 3.02 mm	± 0.08mm
3.05 à 6.10 mm	± 0.13mm
6.12 à 12.70 mm	± 0.20mm
12.73 à 25.40 mm	± 0.38mm
25.43 à 31.12 mm	± 0.51mm
31.14 à 37.08 mm	± 0.76mm
37.11 à 50.08 mm	± 1.02mm
Charge P	± 10%
Raideur H/mm, R	± 10%

Références commençant par 'D'

Toutes les dimensions et charges sont conformes à la DIN 2095 (catégorie 2).

INDEX DES MESURES

- Do = Diamètre extérieur
- d = Diamètre du fil
- Sh = Hauteur solide approximative
- Lo = Longueur libre (pour référence)
- L₁ = Longueur en charge
- P₁ = Charge à L₁, Newton
- R = Raideur N/mm

DONNEES TECHNIQUES ADDITIONNELLES

La corde à piano n'est pas recommandée pour des applications où la température excède 121°C (250°F). L'acier inoxydable n'est pas recommandé pour des applications où la température excède 260°C (500°F). L'acier inoxydable est légèrement magnétique, ceci étant du au travail à froid pendant la fabrication. Les ressorts en acier inoxydable peuvent avoir un léger résidu de nickel sur la surface du fil ; c'est normal et cela n'en affectera pas leur fonction.

EXTRÉMITÉS

Références commençant par 'C'

Diamètre extérieur 1.45 / 2.24 : équerri et non meulé.
Diamètre extérieur > 2.24 : équerri et meulé.

Références commençant par 'D'

Diamètre de fil jusqu'à 0.8mm: équerri et non meulé.
Diamètre de fil à partir de 1mm: équerri et meulé.

ETAT DE SURFACE

Corde à piano : huilé.
Acier inoxydable : brut.
Finition par grenailage et traitements de surface fournis à la demande.

CHARGES

Les valeurs de charge indiquées sont basées sur une longévité de 50 000 cycles à 50% de la tension admissible. En service normal, les ressorts ne doivent pas être compressés en dessous de L₁. Pour déterminer la charge à toute longueur de fonctionnement, multipliez la raideur par la déflexion proposée (pour référence seulement).

- 1 kg. = 9,80665 Newtons
- 1 Newton = 0,10197 kg

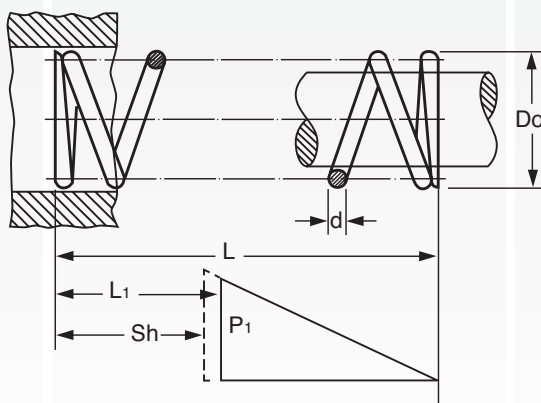

COMPRESSION SPRINGS - MUSIC WIRE								STAINLESS STEEL / INOX		
Part Number	Do (mm)	d (mm)	Lo (mm)	L ₁ (mm)	Sh (mm)	P ₁ (N)	R (N/mm)	Part Number	P ₁ (N)	R (N/mm)
D10100			2.00	1.40	1.30		4.91	D20100		4.09
D10110			2.70	1.90	1.70		3.12	D20110		2.60
D10120	1.20		3.90	2.60	2.30	2.57	2.03	D20120	2.14	1.69
D10130			5.50	3.60	3.10		1.38	D20130		1.15
D10140		0.20	7.80	5.00	4.30		0.92	D20140		0.77
D10150			2.30	1.50	1.30		2.83	D20150		2.36
D10160			3.20	1.90	1.70		1.81	D20160		1.51
D10170	1.40		4.60	2.70	2.30	2.27	1.16	D20170	1.89	0.97
D10180			6.50	3.70	3.10		0.80	D20180		0.67
D10190			9.30	5.10	4.30		0.54	D20190		0.45
C0057-006-0120M			3.05	1.50	1.12		0.67	C0057-006-0120S		0.55
C0057-006-0190M			4.83	2.16	1.52		0.39	C0057-006-0190S		0.32
C0057-006-0250M			6.35	2.69	1.91		0.28	C0057-006-0250S		0.23
C0057-006-0310M			7.87	3.38	2.24		0.23	C0057-006-0310S		0.19
C0057-006-0380M		0.15	9.65	4.34	2.54	1.023	0.19	C0057-006-0380S	0.85	0.16
C0057-006-0440M			11.18	4.67	3.00		0.16	C0057-006-0440S		0.13
C0057-006-0500M			12.70	5.41	3.30		0.14	C0057-006-0500S		0.12
C0057-006-0560M			14.22	6.93	3.28		0.14	C0057-006-0560S		0.12
C0057-006-0620M			15.75	7.39	3.61		0.12	C0057-006-0620S		0.10
C0057-007-0120M			3.05	1.68	1.35		1.23	C0057-007-0120S		1.02
C0057-007-0190M			4.83	2.41	1.88		0.70	C0057-007-0190S		0.58
C0057-007-0250M			6.35	3.23	2.26		0.54	C0057-007-0250S		0.45
C0057-007-0310M			7.87	3.86	2.74		0.42	C0057-007-0310S		0.35
C0057-007-0380M		0.18	9.65	4.57	3.30	1.69	0.33	C0057-007-0380S	1.41	0.28
C0057-007-0440M			11.18	5.49	3.63		0.30	C0057-007-0440S		0.25
C0057-007-0500M	1.45		12.70	6.27	4.01		0.26	C0057-007-0500S		0.22
C0057-007-0560M			14.22	6.76	4.55		0.23	C0057-007-0560S		0.19
C0057-007-0620M			15.75	7.70	4.78		0.21	C0057-007-0620S		0.17
C0057-008-0120M			3.05	1.83	1.55		2.19	C0057-008-0120S		1.82
C0057-008-0190M			4.83	2.72	2.18		1.26	C0057-008-0190S		1.05
C0057-008-0250M			6.35	3.48	2.69		0.93	C0057-008-0250S		0.77
C0057-008-0310M			7.87	4.24	3.23		0.74	C0057-008-0310S		0.61
C0057-008-0380M		0.20	9.65	5.16	3.81	2.67	0.60	C0057-008-0380S	2.22	0.50
C0057-008-0440M			11.18	5.92	4.37		0.51	C0057-008-0440S		0.42
C0057-008-0500M			12.70	6.60	4.95		0.44	C0057-008-0500S		0.36
C0057-008-0560M			14.22	7.29	5.51		0.39	C0057-008-0560S		0.32
C0057-008-0620M			15.75	8.13	5.69		0.35	C0057-008-0620S		0.29
D10350			2.40	1.80	1.63		6.95	D20350		5.79
D10360			3.30	2.40	2.13		4.42	D20360		3.68
D10370		0.25	4.70	3.30	2.88	4.11	2.86	D20370	3.42	2.38
D10380			6.60	4.50	3.88		1.94	D20380		1.62
D10390			9.40	6.30	5.38		1.32	D20390		1.10
D10200			3.00	1.50	1.30		1.20	D20200		1.00
D10210			4.40	2.00	1.70		0.77	D20210		0.64
D10220	1.80	0.20	6.40	2.80	2.30	1.80	0.49	D20220	1.50	0.41
D10230			9.20	3.80	3.10		0.34	D20230		0.28
D10240			13.30	5.30	4.30		0.23	D20240		0.19
D10400			3.00	1.80	1.63		2.93	D20400		2.44
D10410			4.30	2.40	2.13		1.86	D20410		1.55
D10420	1.85	0.25	6.20	3.40	2.88	3.37	1.20	D20420	2.81	1.00
D10430			8.70	4.60	3.88		0.83	D20430		0.69
D10440			12.50	6.50	5.38		0.55	D20440		0.46
D10600			3.10	2.30	2.08		7.86	D20600		6.55
D10610			4.40	3.10	2.72		5.00	D20610		4.17
D10620	1.92	0.32	6.30	4.20	3.68	6.57	3.24	D20620	5.47	2.70
D10630			8.70	5.80	4.96		2.20	D20630		1.83
D10640			12.50	8.10	6.88		1.49	D20640		1.24
D10250			4.00	1.50	1.30		0.61	D20250		0.51
D10260			5.90	2.10	1.70		0.38	D20260		0.32
D10270			8.70	2.90	2.30	1.49	0.25	D20270	1.24	0.21
D10280	2.20	0.20	12.60	4.00	3.10		0.18	D20280		0.15
D10290			18.30	5.60	4.30		0.12	D20290		0.10
C0088-008-0120M			3.05	1.52	1.09	1.69	1.10	C0088-008-0120S		0.92
C0088-008-0190M			4.83	2.06	1.40		0.61	C0088-008-0190S		0.51
C0088-008-0250M			6.35	2.64	1.63		0.46	C0088-008-0250S		0.38
C0088-008-0310M			7.87	3.28	1.85		0.37	C0088-008-0310S		0.31
C0088-008-0380M			9.65	3.96	2.13		0.30	C0088-008-0380S	1.41	0.25
C0088-008-0440M	2.24	0.20	11.18	4.75	2.34	1.69	0.26	C0088-008-0440S		0.22
C0088-008-0500M			12.70	5.28	2.57		0.23	C0088-008-0500S		0.19
C0088-008-0560M			14.22	5.46	2.92		0.19	C0088-008-0560S		0.16
C0088-008-0620M			15.75	6.10	3.02		0.18	C0088-008-0620S		0.15

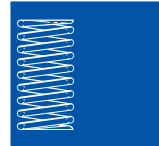

COMPRESSION SPRINGS - MUSIC WIRE								STAINLESS STEEL / INOX		
Part Number	Do (mm)	d (mm)	Lo (mm)	L ₁ (mm)	Sh (mm)	P ₁ (N)	R (N/mm)	Part Number	P ₁ (N)	R (N/mm)
C0088-010-0120M			3.05	1.80	1.52		2.15	C0088-010-0120S		1.79
C0088-010-0190M			4.83	2.59	2.06		1.19	C0088-010-0190S		0.99
C0088-010-0250M			6.35	3.30	2.49		0.88	C0088-010-0250S		0.73
C0088-010-0310M			7.87	3.86	3.00		0.67	C0088-010-0310S		0.55
C0088-010-0380M			9.65	5.03	3.30		0.58	C0088-010-0380S		0.48
C0088-010-0440M		0.25	11.18	5.74	3.73	2.67	0.49	C0088-010-0440S	2.22	0.41
C0088-010-0500M			12.70	6.07	4.37		0.40	C0088-010-0500S		0.34
C0088-010-0560M			14.22	6.96	4.70		0.37	C0088-010-0560S		0.31
C0088-010-0620M			15.75	7.72	5.11		0.33	C0088-010-0620S		0.28
C0088-010-0690M			17.53	8.56	5.41		0.30	C0088-010-0690S		0.25
C0088-010-0750M	2.24		19.05	9.53	5.79		0.28	C0088-010-0750S		0.23
C0088-012-0120M			3.05	1.96	1.91		4.31	C0088-012-0120S		3.59
C0088-012-0190M			4.83	2.95	2.54		2.54	C0088-012-0190S		2.12
C0088-012-0250M			6.35	3.76	3.12		1.84	C0088-012-0250S		1.53
C0088-012-0310M			7.87	4.47	3.76		1.40	C0088-012-0310S		1.17
C0088-012-0380M		0.30	9.65	5.49	4.37	4.76	1.14	C0088-012-0380S	3.97	0.95
C0088-012-0440M			11.18	6.40	4.85		1.00	C0088-012-0440S		0.83
C0088-012-0500M			12.70	7.16	5.46		0.86	C0088-012-0500S		0.71
C0088-012-0560M			14.22	8.05	5.97		0.77	C0088-012-0560S		0.64
C0088-012-0620M			15.75	8.59	6.73		0.67	C0088-012-0620S		0.55
C0088-012-0690M			17.53	9.75	6.76		0.61	C0088-012-0690S		0.51
C0088-012-0750M			19.05	10.57	7.44		0.56	C0088-012-0750S		0.47
D10450			3.70	1.90	1.63		1.50	D20450		1.25
D10460			5.50	2.50	2.13		0.95	D20460		0.79
D10470	2.25	0.25	8.00	3.50	2.88	2.81	0.61	D20470	2.34	0.51
D10480			11.40	4.70	3.88		0.42	D20480		0.35
D10490			16.60	6.70	5.38		0.29	D20490		0.24
D10650			3.70	2.30	2.08		4.02	D20650		3.35
D10660			5.30	3.10	2.72		2.57	D20660		2.14
D10670	2.32	0.32	7.70	4.30	3.68	5.63	1.66	D20670	4.69	1.38
D10680			10.90	5.90	4.96		1.13	D20680		0.94
D10690			15.60	8.20	6.88		0.77	D20690		0.64
D10850			3.50	2.70	2.60		9.31	D20850		7.76
D10860			5.00	3.70	3.40		5.88	D20860		4.90
D10870	2.40	0.40	7.00	5.10	4.60	7.45	3.83	D20870	6.21	3.19
D10880			10.00	7.00	6.20		2.61	D20880		2.17
D10890			14.00	9.90	8.60		1.76	D20890		1.47
D10300			5.40	1.60	1.30		0.31	D20300		0.26
D10310			8.20	2.20	1.70		0.20	D20310		0.17
D10320	2.70	0.20	12.40	3.10	2.30	1.20	0.13	D20320	1.00	0.11
D10330			17.90	4.20	3.10		0.08	D20330		0.07
D10340			26.20	5.90	4.30		0.06	D20340		0.05
D10500			4.90	1.90	1.63		0.77	D20500		0.64
D10510			7.30	2.60	2.13		0.49	D20510		0.41
D10520	2.75	0.25	10.90	3.60	2.88	2.31	0.31	D20520	1.92	0.26
D10530			15.70	5.00	3.88		0.22	D20530		0.18
D10540			22.90	7.00	5.38		0.14	D20540		0.12
D10700			4.70	2.40	2.08		2.06	D20700		1.72
D10710			6.80	3.20	2.72		1.31	D20710		1.09
D10720	2.82	0.32	10.00	4.40	3.68	4.69	0.85	D20720	3.91	0.71
D10730			14.20	6.10	4.96		0.58	D20730		0.48
D10740			20.60	8.50	6.88		0.38	D20740		0.32
D10900			4.30	2.80	2.60		4.77	D20900		3.97
D10910			6.30	3.90	3.40		3.04	D20910		2.53
D10920	2.90	0.40	9.10	5.40	4.60	7.16	1.96	D20920	5.96	1.63
D10930			13.00	7.50	6.20		1.33	D20930		1.11
D10940			18.50	10.60	8.60		0.90	D20940		0.75
D11100			4.40	3.50	3.25		11.58	D21100		9.65
D11110			6.10	4.70	4.25		7.42	D21110		6.18
D11120	3.00	0.50	8.70	6.50	5.75	10.40	4.80	D21120	8.66	4.00
D11130			12.00	9.00	7.75		3.27	D21130		2.72
D11140			17.50	12.80	10.75		2.21	D21140		1.84
C0120-010-0250M			6.35	2.57	1.63		0.56	C0120-010-0250S		0.47
C0120-010-0310M			7.87	3.00	1.85		0.44	C0120-010-0310S		0.36
C0120-010-0380M			9.65	3.56	2.11		0.35	C0120-010-0380S		0.29
C0120-010-0440M			11.18	4.01	2.34		0.30	C0120-010-0440S		0.25
C0120-010-0500M	3.05	0.25	12.70	4.57	2.57	2.14	0.26	C0120-010-0500S	1.78	0.22
C0120-010-0560M			14.22	5.51	2.77		0.25	C0120-010-0560S		0.20
C0120-010-0620M			15.75	5.59	3.00		0.21	C0120-010-0620S		0.17
C0120-010-0690M			17.53	6.50	3.28		0.19	C0120-010-0690S		0.16
C0120-010-0750M			19.05	6.86	3.48		0.18	C0120-010-0750S		0.15

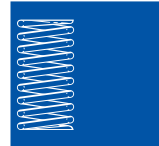

COMPRESSION SPRINGS - MUSIC WIRE								STAINLESS STEEL / INOX		
Part Number	Do (mm)	d (mm)	Lo (mm)	L ₁ (mm)	Sh (mm)	P ₁ (N)	R (N/mm)	Part Number	P ₁ (N)	R (N/mm)
C0120-010-0810M			20.57	7.04	3.71		0.16	C0120-010-0810S		0.13
C0120-010-0880M			22.35	8.81	3.96		0.16	C0120-010-0880S		0.13
C0120-010-0940M			23.88	8.71	4.19		0.14	C0120-010-0940S		0.12
C0120-010-1000M		0.25	25.40	7.98	4.42	2.14	0.12	C0120-010-1000S	1.78	0.10
C0120-010-1120M			28.45	11.02	4.88		0.12	C0120-010-1120S		0.10
C0120-010-1250M			31.75	11.48	5.36		0.11	C0120-010-1250S		0.09
C0120-010-1500M			38.10	13.72	6.30		0.09	C0120-010-1500S		0.07
C0120-012-0250M			6.35	3.15	2.06		1.10	C0120-012-0250S		0.92
C0120-012-0310M			7.87	3.86	2.36		0.88	C0120-012-0310S		0.73
C0120-012-0380M			9.65	4.60	2.72		0.70	C0120-012-0380S		0.58
C0120-012-0440M			11.18	5.26	3.02		0.60	C0120-012-0440S		0.50
C0120-012-0500M			12.70	6.02	3.33		0.53	C0120-012-0500S		0.44
C0120-012-0560M			14.22	6.50	3.63		0.46	C0120-012-0560S		0.38
C0120-012-0620M			15.75	7.39	3.94		0.42	C0120-012-0620S		0.35
C0120-012-0690M		0.30	17.53	8.05	4.29	3.51	0.37	C0120-012-0690S	2.92	0.31
C0120-012-0750M			19.05	9.02	4.60		0.35	C0120-012-0750S		0.29
C0120-012-0810M			20.57	9.40	4.90		0.32	C0120-012-0810S		0.26
C0120-012-0880M			22.35	10.54	5.26		0.30	C0120-012-0880S		0.25
C0120-012-0940M			23.88	10.49	5.56		0.26	C0120-012-0940S		0.22
C0120-012-1000M			25.40	12.01	5.87		0.26	C0120-012-1000S		0.22
C0120-012-1120M			28.45	12.88	6.48		0.23	C0120-012-1120S		0.19
C0120-012-1250M			31.75	15.04	7.14		0.21	C0120-012-1250S		0.17
C0120-012-1500M			38.10	18.03	8.41		0.18	C0120-012-1500S		0.15
C0120-014-0250M			6.35	3.51	2.57		1.93	C0120-014-0250S		1.60
C0120-014-0310M			7.87	4.24	2.97		1.51	C0120-014-0310S		1.25
C0120-014-0380M			9.65	5.13	3.45		1.21	C0120-014-0380S		1.01
C0120-014-0440M			11.18	5.89	3.86		1.03	C0120-014-0440S		0.86
C0120-014-0500M			12.70	6.68	4.27		0.91	C0120-014-0500S		0.76
C0120-014-0560M			14.22	7.39	4.67		0.81	C0120-014-0560S		0.67
C0120-014-0620M			15.75	8.13	5.08		0.72	C0120-014-0620S		0.60
C0120-014-0690M		0.36	17.53	9.02	5.56	5.47	0.65	C0120-014-0690S	4.56	0.54
C0120-014-0750M			19.05	9.78	5.97		0.60	C0120-014-0750S		0.50
C0120-014-0810M			20.57	10.52	6.38		0.54	C0120-014-0810S		0.45
C0120-014-0880M			22.35	11.58	6.83		0.51	C0120-014-0880S		0.42
C0120-014-0940M			23.88	12.29	7.24		0.47	C0120-014-0940S		0.39
C0120-014-1000M		3.05	25.40	12.90	7.65		0.44	C0120-014-1000S		0.36
C0120-014-1120M			28.45	14.25	8.46		0.39	C0120-014-1120S		0.32
C0120-014-1250M			31.75	16.05	9.35		0.35	C0120-014-1250S		0.29
C0120-014-1500M			38.10	19.71	11.02		0.30	C0120-014-1500S		0.25
C0120-016-0190M			4.83	3.00	2.57		4.48	C0120-016-0190S		3.73
C0120-016-0250M			6.35	3.68	3.02		3.06	C0120-016-0250S		2.55
C0120-016-0310M			7.87	4.55	3.53		2.45	C0120-016-0310S		2.04
C0120-016-0380M			9.65	5.51	4.14		1.98	C0120-016-0380S		1.65
C0120-016-0440M			11.18	6.25	4.75		1.66	C0120-016-0440S		1.39
C0120-016-0500M			12.70	7.11	5.28		1.45	C0120-016-0500S		1.21
C0120-016-0560M		0.41	14.22	7.82	5.87	8.18	1.28	C0120-016-0560S	6.81	1.06
C0120-016-0620M			15.75	8.69	6.38		1.16	C0120-016-0620S		0.96
C0120-016-0690M			17.53	9.53	7.14		1.02	C0120-016-0690S		0.85
C0120-016-0750M			19.05	10.26	7.70		0.93	C0120-016-0750S		0.77
C0120-016-1000M			25.40	14.00	9.60		0.72	C0120-016-1000S		0.60
C0120-016-1120M			28.45	15.47	10.64		0.63	C0120-016-1120S		0.52
C0120-016-1250M			31.75	17.15	11.76		0.56	C0120-016-1250S		0.47
C0120-016-1500M			38.10	21.41	13.82		0.49	C0120-016-1500S		0.41
C0120-018-0190M			4.83	3.25	2.97		7.23	C0120-018-0190S		6.02
C0120-018-0250M			6.35	4.04	3.53		4.94	C0120-018-0250S		4.12
C0120-018-0310M			7.87	4.90	4.22		3.84	C0120-018-0310S		3.20
C0120-018-0380M			9.65	6.02	4.93		3.13	C0120-018-0380S		2.61
C0120-018-0440M			11.18	6.88	5.59		2.66	C0120-018-0440S		2.22
C0120-018-0500M			12.70	7.75	6.30		2.29	C0120-018-0500S		1.91
C0120-018-0560M		0.46	14.22	8.53	7.09	11.39	2.00	C0120-018-0560S	9.49	1.66
C0120-018-0620M			15.75	9.60	7.54		1.86	C0120-018-0620S		1.55
C0120-018-0690M			17.53	10.52	8.43		1.63	C0120-018-0690S		1.36
C0120-018-0750M			19.05	11.38	9.12		1.49	C0120-018-0750S		1.24
C0120-018-1000M			25.40	15.24	11.56		1.12	C0120-018-1000S		0.93
C0120-018-1120M			28.45	17.04	12.83		1.00	C0120-018-1120S		0.83
C0120-018-1250M			31.75	19.00	14.20		0.89	C0120-018-1250S		0.74
C0120-018-1500M			38.10	22.61	16.84		0.74	C0120-018-1500S		0.61
C0120-020-0250M			6.35	4.47	4.14		7.84	C0120-020-0250S		6.53
C0120-020-0310M		0.51	7.87	5.46	4.88	14.72	6.09	C0120-020-0310S	12.26	5.07
C0120-020-0380M			9.65	6.60	5.74		4.85	C0120-020-0380S		4.04
C0120-020-0440M			11.18	7.59	6.50		4.12	C0120-020-0440S		3.43

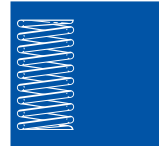

COMPRESSION SPRINGS - MUSIC WIRE								STAINLESS STEEL / INOX		
Part Number	Do (mm)	d (mm)	Lo (mm)	L ₁ (mm)	Sh (mm)	P ₁ (N)	R (N/mm)	Part Number	P ₁ (N)	R (N/mm)
C0120-020-0500M			12.70	8.59	7.24		3.57	C0120-020-0500S		2.97
C0120-020-0560M			14.22	9.58	7.98		3.17	C0120-020-0560S		2.64
C0120-020-0620M			15.75	10.57	8.74		2.84	C0120-020-0620S		2.37
C0120-020-0690M			17.53	11.71	9.60		2.54	C0120-020-0690S		2.12
C0120-020-0750M			19.05	12.70	10.34		2.31	C0120-020-0750S		1.92
C0120-020-0810M		0.51	20.57	13.69	11.10	14.72	2.14	C0120-020-0810S	12.26	1.78
C0120-020-0880M			22.35	14.83	11.96		1.96	C0120-020-0880S		1.63
C0120-020-0940M			23.88	15.82	12.70		1.82	C0120-020-0940S		1.52
C0120-020-1000M			25.40	16.81	13.46		1.72	C0120-020-1000S		1.43
C0120-020-1120M			28.45	18.77	14.94		1.52	C0120-020-1120S		1.27
C0120-020-1250M			31.75	20.93	16.56		1.37	C0120-020-1250S		1.14
C0120-020-1500M			38.10	25.02	19.66		1.12	C0120-020-1500S		0.93
C0120-022-0250M			6.35	4.75	4.34		12.36	C0120-022-0250S		10.30
C0120-022-0310M			7.87	5.74	5.31		9.33	C0120-022-0310S		7.77
C0120-022-0380M			9.65	6.91	6.40		7.27	C0120-022-0380S		6.06
C0120-022-0440M			11.18	8.05	7.11		6.37	C0120-022-0440S		5.31
C0120-022-0500M			12.70	9.04	8.10		5.45	C0120-022-0500S		4.54
C0120-022-0560M			14.22	10.19	8.79		4.94	C0120-022-0560S		4.12
C0120-022-0620M			15.75	11.18	9.75		4.36	C0120-022-0620S		3.63
C0120-022-0690M	3.05	0.56	17.53	12.17	11.23	19.93	3.71	C0120-022-0690S	16.60	3.09
C0120-022-0750M			19.05	13.41	11.71		3.54	C0120-022-0750S		2.95
C0120-022-0810M			20.57	14.48	12.55		3.27	C0120-022-0810S		2.72
C0120-022-0940M			23.88	16.64	14.38		2.75	C0120-022-0940S		2.29
C0120-022-1000M			25.40	17.65	15.24		2.57	C0120-022-1000S		2.14
C0120-022-1120M			28.45	20.12	16.94		2.40	C0120-022-1120S		2.00
C0120-022-1250M			31.75	22.02	18.77		2.05	C0120-022-1250S		1.71
C0120-022-1500M			38.10	26.37	22.33		1.70	C0120-022-1500S		1.41
C0120-024-0310M			7.87	6.15	5.82		14.41	C0120-024-0310S		12.00
C0120-024-0380M			9.65	7.44	6.88		11.36	C0120-024-0380S		9.46
C0120-024-0440M			11.18	8.59	7.80		9.63	C0120-024-0440S		8.02
C0120-024-0500M			12.70	9.70	8.71		8.35	C0120-024-0500S		6.96
C0120-024-0560M			14.22	10.82	9.63		7.37	C0120-024-0560S		6.14
C0120-024-0620M			15.75	11.96	10.54		6.60	C0120-024-0620S		5.50
C0120-024-0690M			17.53	13.26	11.61		5.88	C0120-024-0690S		4.90
C0120-024-0750M		0.61	19.05	14.40	12.52	25.04	5.38	C0120-024-0750S	20.86	4.48
C0120-024-0810M			20.57	15.52	13.44		4.96	C0120-024-0810S		4.13
C0120-024-0880M			22.35	16.84	14.50		4.54	C0120-024-0880S		3.78
C0120-024-0940M			23.88	17.96	15.42		4.24	C0120-024-0940S		3.53
C0120-024-1000M			25.40	19.08	16.33		3.96	C0120-024-1000S		3.30
C0120-024-1120M			28.45	21.34	18.16		3.52	C0120-024-1120S		2.93
C0120-024-1250M			31.75	23.77	20.14		3.13	C0120-024-1250S		2.61
C0120-024-1500M			38.10	28.47	23.95		2.61	C0120-024-1500S		2.17
D10550			7.10	2.00	1.63		0.36	D20550		0.30
D10560			10.70	2.80	2.13		0.24	D20560		0.20
D10570	3.45	0.25	16.10	3.80	2.88	1.84	0.16	D20570	1.53	0.13
D10580			23.30	5.30	3.88		0.11	D20580		0.09
D10590			34.10	7.50	5.38		0.07	D20590		0.06
D10750			6.30	2.50	2.08		0.97	D20750		0.81
D10760			9.40	3.30	2.72		0.62	D20760		0.52
D10770	3.52	0.32	14.00	4.60	3.68	3.79	0.40	D20770	3.16	0.33
D10780			20.10	6.30	4.96		0.28	D20780		0.23
D10790			29.30	8.90	6.88		0.19	D20790		0.16
D10950			5.60	2.80	2.60		2.28	D20950		1.90
D10960			8.30	3.90	3.40		1.45	D20960		1.21
D10970	3.60	0.40	12.00	5.40	4.60	6.37	0.94	D20970	5.31	0.78
D10980			17.50	7.50	6.20		0.64	D20980		0.53
D10990			25.50	10.60	8.60		0.43	D20990		0.36
D11150			5.50	3.70	3.25		5.57	D21150		4.64
D11160			7.90	5.10	4.25		3.53	D21160		2.94
D11170	3.70	0.50	11.50	7.10	5.75	10.00	2.28	D21170	8.33	1.90
D11180			16.00	9.80	7.75		1.56	D21180		1.30
D11190			23.50	14.00	10.75		1.05	D21190		0.87
C0148-021-0250M			6.35	4.11	3.63		6.25	C0148-021-0250S		5.21
C0148-021-0310M			7.87	4.98	4.22		4.85	C0148-021-0310S		4.04
C0148-021-0380M			9.65	6.02	4.90		3.85	C0148-021-0380S		3.21
C0148-021-0440M			11.18	6.88	5.51		3.27	C0148-021-0440S		2.72
C0148-021-0500M	3.76	0.53	12.70	7.77	6.10	14.01	2.84	C0148-021-0500S	11.67	2.37
C0148-021-0560M			14.22	8.66	6.68		2.50	C0148-021-0560S		2.08
C0148-021-0620M			15.75	9.53	7.26		2.24	C0148-021-0620S		1.87
C0148-021-0690M			17.53	10.54	7.95		2.01	C0148-021-0690S		1.67
C0148-021-0750M			19.05	11.43	8.53		1.84	C0148-021-0750S		1.53

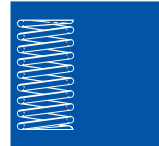

COMPRESSION SPRINGS - MUSIC WIRE								STAINLESS STEEL / INOX		
Part Number	Do (mm)	d (mm)	Lo (mm)	L ₁ (mm)	Sh (mm)	P ₁ (N)	R (N/mm)	Part Number	P ₁ (N)	R (N/mm)
C0148-021-0810M			20.57	12.32	9.12		1.70	C0148-021-0810S		1.41
C0148-021-0880M			22.35	13.34	9.80		1.56	C0148-021-0880S		1.30
C0148-021-0940M		0.53	23.88	14.22	10.41	14.01	1.45	C0148-021-0940S	11.67	1.21
C0148-021-1000M			25.40	15.09	11.00		1.37	C0148-021-1000S		1.14
C0148-021-1250M			31.75	18.75	13.44		1.07	C0148-021-1250S		0.89
C0148-021-1500M			38.10	22.40	15.90		0.89	C0148-021-1500S		0.74
C0148-023-0250M			6.35	4.37	4.06		9.11	C0148-023-0250S		7.59
C0148-023-0310M			7.87	5.31	4.75		7.02	C0148-023-0310S		5.85
C0148-023-0380M			9.65	6.43	5.54		5.55	C0148-023-0380S		4.62
C0148-023-0440M	3.76		11.18	7.37	6.22		4.71	C0148-023-0440S		3.92
C0148-023-0500M			12.70	8.31	6.91		4.08	C0148-023-0500S		3.40
C0148-023-0560M			14.22	9.25	7.59		3.61	C0148-023-0560S		3.01
C0148-023-0620M			15.75	10.19	8.28		3.24	C0148-023-0620S		2.70
C0148-023-0690M		0.58	17.53	11.28	9.07	17.97	2.89	C0148-023-0690S	14.97	2.41
C0148-023-0750M			19.05	12.22	9.75		2.64	C0148-023-0750S		2.20
C0148-023-0810M			20.57	13.16	10.41		2.43	C0148-023-0810S		2.02
C0148-023-0880M			22.35	14.27	11.23		2.22	C0148-023-0880S		1.85
C0148-023-0940M			23.88	15.21	11.91		2.08	C0148-023-0940S		1.73
C0148-023-1000M			25.40	16.15	12.57		1.94	C0148-023-1000S		1.62
C0148-023-1250M			31.75	20.09	15.42		1.54	C0148-023-1250S		1.28
C0148-023-1500M			38.10	24.00	18.26		1.28	C0148-023-1500S		1.06
D11350			5.50	4.00	4.10		14.02	D21350		11.68
D11360			7.80	5.40	5.36		8.90	D21360		7.41
D11370	3.83	0.63	11.00	7.50	7.25	20.99	5.77	D21370	17.48	4.81
D11380			15.50	10.30	9.77		3.93	D21380		3.27
D11390			22.50	14.70	13.55		2.65	D21390		2.21
D10800			8.70	2.60	2.08		0.50	D20800		0.42
D10810			13.10	3.50	2.72		0.31	D20810		0.26
D10820	4.32	0.32	19.80	4.90	3.68	3.09	0.22	D20820	2.57	0.18
D10830			28.60	6.70	4.96		0.14	D20830		0.12
D10840			41.90	9.50	6.88		0.10	D20840		0.08
D11000			7.50	3.00	2.60		1.17	D21000		0.97
D11010			11.00	4.10	3.40		0.74	D21010		0.62
D11020	4.40	0.40	16.50	5.80	4.60	5.25	0.48	D21020	4.37	0.40
D11030			24.00	8.00	6.20		0.32	D21030		0.27
D11040			35.50	11.40	8.60		0.22	D21040		0.18
D11200			7.00	3.70	3.25		2.83	D21200		2.36
D11210			10.00	5.10	4.25		1.81	D21210		1.51
D11220	4.50	0.50	15.00	7.10	5.75	9.32	1.17	D21220	7.76	0.97
D11230			21.50	9.80	7.75		0.79	D21230		0.66
D11240			31.00	14.00	10.75		0.54	D21240		0.45
C0180-012-0250M			6.35	2.57	1.45		0.63	C0180-012-0250S		0.52
C0180-012-0310M			7.87	3.15	1.57		0.51	C0180-012-0310S		0.42
C0180-012-0380M			9.65	3.68	1.75		0.40	C0180-012-0380S		0.34
C0180-012-0440M			11.18	4.32	1.88		0.35	C0180-012-0440S		0.29
C0180-012-0500M			12.70	4.62	2.03		0.30	C0180-012-0500S		0.25
C0180-012-0560M			14.22	5.08	2.16		0.26	C0180-012-0560S		0.22
C0180-012-0620M			15.75	5.94	2.31		0.25	C0180-012-0620S		0.20
C0180-012-0690M		0.30	17.53	6.10	2.46	2.40	0.21	C0180-012-0690S	2.00	0.17
C0180-012-0750M			19.05	6.58	2.62		0.19	C0180-012-0750S		0.16
C0180-012-0810M			20.57	6.86	2.77		0.18	C0180-012-0810S		0.15
C0180-012-0880M			22.35	8.64	2.92		0.18	C0180-012-0880S		0.15
C0180-012-0940M			23.88	8.53	3.07		0.16	C0180-012-0940S		0.13
C0180-012-1000M			25.40	8.26	3.20		0.14	C0180-012-1000S		0.12
C0180-012-1250M			31.75	12.17	3.78		0.12	C0180-012-1250S		0.10
C0180-012-1500M	4.57		38.10	15.24	4.37		0.11	C0180-012-1500S		0.09
C0180-014-0250M			6.35	2.92	1.75		1.09	C0180-014-0250S		0.90
C0180-014-0310M			7.87	3.53	1.93		0.86	C0180-014-0310S		0.71
C0180-014-0380M			9.65	4.19	2.16		0.68	C0180-014-0380S		0.57
C0180-014-0440M			11.18	4.90	2.34		0.60	C0180-014-0440S		0.50
C0180-014-0500M			12.70	5.33	2.54		0.51	C0180-014-0500S		0.42
C0180-014-0560M			14.22	6.05	2.72		0.46	C0180-014-0560S		0.38
C0180-014-0620M		0.36	15.75	6.48	2.90	3.74	0.40	C0180-014-0620S	3.12	0.34
C0180-014-0690M			17.53	7.34	3.12		0.37	C0180-014-0690S		0.31
C0180-014-0750M			19.05	7.82	3.30		0.33	C0180-014-0750S		0.28
C0180-014-0880M			22.35	9.02	3.71		0.28	C0180-014-0880S		0.23
C0180-014-1000M			25.40	10.16	4.09		0.25	C0180-014-1000S		0.20
C0180-014-1250M			31.75	12.34	4.85		0.19	C0180-014-1250S		0.16
C0180-014-1380M			35.05	13.72	5.26		0.18	C0180-014-1380S		0.15
C0180-014-1500M			38.10	14.40	5.64		0.16	C0180-014-1500S		0.13
C0180-016-0250M		0.41	6.35	2.77	2.03	5.56	1.56	C0180-016-0250S	4.63	1.30

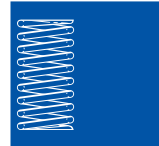

COMPRESSION SPRINGS - MUSIC WIRE								STAINLESS STEEL / INOX		
Part Number	Do (mm)	d (mm)	Lo (mm)	L ₁ (mm)	Sh (mm)	P ₁ (N)	R (N/mm)	Part Number	P ₁ (N)	R (N/mm)
C0180-016-0310M			7.87	3.63	2.21		1.31	C0180-016-0310S		1.09
C0180-016-0380M			9.65	4.29	2.54		1.03	C0180-016-0380S		0.86
C0180-016-0440M			11.18	4.75	2.84		0.86	C0180-016-0440S		0.71
C0180-016-0500M			12.70	5.21	3.15		0.74	C0180-016-0500S		0.61
C0180-016-0560M			14.22	5.66	3.45		0.65	C0180-016-0560S		0.54
C0180-016-0620M			15.75	6.45	3.66		0.60	C0180-016-0620S		0.50
C0180-016-0690M		0.41	17.53	7.19	3.94	5.56	0.54	C0180-016-0690S	4.63	0.45
C0180-016-0750M			19.05	7.62	4.24		0.49	C0180-016-0750S		0.41
C0180-016-0880M			22.35	9.65	4.70		0.44	C0180-016-0880S		0.36
C0180-016-1000M			25.40	10.97	5.18		0.39	C0180-016-1000S		0.32
C0180-016-1250M			31.75	13.08	6.22		0.30	C0180-016-1250S		0.25
C0180-016-1380M			35.05	15.24	6.76		0.28	C0180-016-1380S		0.23
C0180-016-1500M			38.10	15.42	7.24		0.25	C0180-016-1500S		0.20
C0180-016-1750M			44.45	17.98	8.28		0.21	C0180-016-1750S		0.17
C0180-018-0250M			6.35	3.05	2.39		2.36	C0180-018-0250S		1.97
C0180-018-0310M			7.87	3.96	2.62		2.00	C0180-018-0310S		1.66
C0180-018-0380M			9.65	4.83	2.95		1.63	C0180-018-0380S		1.36
C0180-018-0440M			11.18	5.46	3.30		1.37	C0180-018-0440S		1.14
C0180-018-0500M			12.70	6.07	3.66		1.17	C0180-018-0500S		0.98
C0180-018-0560M			14.22	6.40	4.11		1.00	C0180-018-0560S		0.83
C0180-018-0620M			15.75	7.01	4.45		0.89	C0180-018-0620S		0.74
C0180-018-0690M		0.46	17.53	7.87	4.80	7.83	0.81	C0180-018-0690S	6.52	0.67
C0180-018-0750M			19.05	8.20	5.26		0.72	C0180-018-0750S		0.60
C0180-018-0880M			22.35	10.26	5.77		0.65	C0180-018-0880S		0.54
C0180-018-1000M			25.40	11.43	6.40		0.56	C0180-018-1000S		0.47
C0180-018-1250M			31.75	14.55	7.70		0.46	C0180-018-1250S		0.38
C0180-018-1380M			35.05	15.62	8.38		0.40	C0180-018-1380S		0.34
C0180-018-1500M			38.10	16.81	9.02		0.37	C0180-018-1500S		0.31
C0180-018-1750M			44.45	19.61	10.31		0.32	C0180-018-1750S		0.26
C0180-020-0250M			6.35	3.61	2.87		3.71	C0180-020-0250S		3.09
C0180-020-0310M			7.87	4.34	3.25		2.89	C0180-020-0310S		2.41
C0180-020-0380M			9.65	5.21	3.71		2.29	C0180-020-0380S		1.91
C0180-020-0440M			11.18	5.94	4.09		1.94	C0180-020-0440S		1.62
C0180-020-0500M			12.70	6.68	4.47		1.70	C0180-020-0500S		1.41
C0180-020-0560M			14.22	7.42	4.85		1.51	C0180-020-0560S		1.25
C0180-020-0620M	4.57		15.75	8.15	5.26		1.35	C0180-020-0620S		1.12
C0180-020-0690M		0.51	17.53	9.02	5.69	10.19	1.19	C0180-020-0690S	8.49	0.99
C0180-020-0750M			19.05	9.75	6.07		1.10	C0180-020-0750S		0.92
C0180-020-0880M			22.35	11.35	6.91		0.93	C0180-020-0880S		0.77
C0180-020-1000M			25.40	12.83	7.67		0.81	C0180-020-1000S		0.67
C0180-020-1250M			31.75	15.90	9.30		0.65	C0180-020-1250S		0.54
C0180-020-1380M			35.05	17.50	10.11		0.58	C0180-020-1380S		0.48
C0180-020-1500M			38.10	18.72	10.90		0.53	C0180-020-1500S		0.44
C0180-020-1750M			44.45	22.05	12.50		0.46	C0180-020-1750S		0.38
C0180-022-0250M			6.35	3.66	3.07		5.18	C0180-022-0250S		4.31
C0180-022-0310M			7.87	4.52	3.48		4.15	C0180-022-0310S		3.46
C0180-022-0380M			9.65	5.64	3.91		3.47	C0180-022-0380S		2.89
C0180-022-0440M			11.18	6.48	4.32		2.96	C0180-022-0440S		2.47
C0180-022-0500M			12.70	7.11	4.88		2.49	C0180-022-0500S		2.07
C0180-022-0560M			14.22	7.52	5.56		2.08	C0180-022-0560S		1.73
C0180-022-0620M			15.75	8.18	6.12		1.84	C0180-022-0620S		1.53
C0180-022-0690M		0.56	17.53	9.27	6.58	13.92	1.68	C0180-022-0690S	11.60	1.40
C0180-022-0750M			19.05	9.88	7.11		1.52	C0180-022-0750S		1.27
C0180-022-0810M			20.57	10.29	7.85		1.35	C0180-022-0810S		1.12
C0180-022-0940M			23.88	12.34	8.56		1.21	C0180-022-0940S		1.01
C0180-022-1000M			25.40	13.16	9.02		1.14	C0180-022-1000S		0.95
C0180-022-1120M			28.45	14.73	9.93		1.02	C0180-022-1120S		0.85
C0180-022-1250M			31.75	16.46	10.92		0.91	C0180-022-1250S		0.76
C0180-022-1500M			38.10	19.61	12.85		0.75	C0180-022-1500S		0.63
C0180-022-1750M			44.45	23.60	13.97		0.67	C0180-022-1750S		0.55
C0180-024-0250M			6.35	4.06	3.63		7.41	C0180-024-0250S		6.17
C0180-024-0310M			7.87	4.90	4.17		5.71	C0180-024-0310S		4.76
C0180-024-0380M			9.65	5.89	4.80		4.50	C0180-024-0380S		3.75
C0180-024-0440M			11.18	6.73	5.33		3.82	C0180-024-0440S		3.18
C0180-024-0500M			12.70	7.57	5.89		3.31	C0180-024-0500S		2.76
C0180-024-0560M		0.61	14.22	8.41	6.43	16.95	2.92	C0180-024-0560S	14.12	2.43
C0180-024-0620M			15.75	9.27	6.96		2.61	C0180-024-0620S		2.17
C0180-024-0750M			19.05	11.10	8.13		2.14	C0180-024-0750S		1.78
C0180-024-0880M			22.35	12.93	9.30		1.80	C0180-024-0880S		1.50
C0180-024-1000M			25.40	14.61	10.36		1.58	C0180-024-1000S		1.31
C0180-024-1120M			28.45	16.28	11.43		1.40	C0180-024-1120S		1.17

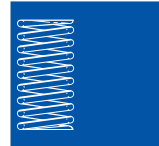

COMPRESSION SPRINGS - MUSIC WIRE								STAINLESS STEEL / INOX		
Part Number	Do (mm)	d (mm)	Lo (mm)	L ₁ (mm)	Sh (mm)	P ₁ (N)	R (N/mm)	Part Number	P ₁ (N)	R (N/mm)
C0180-024-1250M			31.75	18.11	12.60		1.24	C0180-024-1250S		1.04
C0180-024-1500M		0.61	38.10	21.64	14.86	16.95	1.03	C0180-024-1500S	14.12	0.86
C0180-024-1750M			44.45	25.15	17.09		0.88	C0180-024-1750S		0.73
C0180-024-2000M			50.80	28.68	19.33		0.77	C0180-024-2000S		0.64
C0180-026-0250M			6.35	4.14	3.78		10.12	C0180-026-0250S		8.43
C0180-026-0310M			7.87	5.16	4.27		8.23	C0180-026-0310S		6.86
C0180-026-0380M			9.65	6.25	4.95		6.57	C0180-026-0380S		5.47
C0180-026-0440M			11.18	7.09	5.61		5.46	C0180-026-0440S		4.55
C0180-026-0500M			12.70	7.92	6.27		4.69	C0180-026-0500S		3.91
C0180-026-0560M			14.22	8.79	6.91		4.12	C0180-026-0560S		3.43
C0180-026-0620M			15.75	9.63	7.57		3.66	C0180-026-0620S		3.05
C0180-026-0690M			17.53	10.72	8.23		3.29	C0180-026-0690S		2.74
C0180-026-0750M		0.66	19.05	11.56	8.94	22.38	2.98	C0180-026-0750S	18.64	2.48
C0180-026-0810M			20.57	12.40	9.58		2.73	C0180-026-0810S		2.27
C0180-026-0880M			22.35	13.51	10.24		2.52	C0180-026-0880S		2.10
C0180-026-1000M			25.40	14.94	11.71		2.14	C0180-026-1000S		1.78
C0180-026-1120M			28.45	16.61	12.93		1.89	C0180-026-1120S		1.58
C0180-026-1250M			31.75	18.57	14.27		1.70	C0180-026-1250S		1.41
C0180-026-1500M			38.10	22.12	16.84		1.40	C0180-026-1500S		1.17
C0180-026-1750M			44.45	25.65	19.41		1.19	C0180-026-1750S		0.99
C0180-026-2000M			50.80	29.13	21.97		1.03	C0180-026-2000S		0.86
C0180-029-0250M			6.35	4.60	4.37		16.30	C0180-029-0250S		13.58
C0180-029-0310M			7.87	5.56	5.28		12.43	C0180-029-0310S		10.35
C0180-029-0380M			9.65	6.71	6.12		9.72	C0180-029-0380S		8.10
C0180-029-0440M			11.18	7.70	6.86		8.20	C0180-029-0440S		6.83
C0180-029-0500M			12.70	8.66	7.59		7.09	C0180-029-0500S		5.91
C0180-029-0560M			14.22	9.65	8.31		6.23	C0180-029-0560S		5.19
C0180-029-0620M			15.75	10.62	9.04		5.57	C0180-029-0620S		4.64
C0180-029-0690M			17.53	11.76	9.91		4.96	C0180-029-0690S		4.13
C0180-029-0750M			19.05	12.73	10.62		4.52	C0180-029-0750S		3.77
C0180-029-0810M		0.74	20.57	13.72	11.35	28.60	4.17	C0180-029-0810S	23.82	3.47
C0180-029-0880M			22.35	14.83	12.22		3.82	C0180-029-0880S		3.18
C0180-029-0940M			23.88	15.82	12.93		3.56	C0180-029-0940S		2.97
C0180-029-1000M			25.40	16.79	13.67		3.33	C0180-029-1000S		2.77
C0180-029-1120M			28.45	18.75	15.14		2.94	C0180-029-1120S		2.45
C0180-029-1250M		4.57	31.75	20.85	16.71		2.63	C0180-029-1250S		2.19
C0180-029-1380M			35.05	22.99	18.29		2.36	C0180-029-1380S		1.97
C0180-029-1500M			38.10	24.94	19.76		2.17	C0180-029-1500S		1.81
C0180-029-1750M			44.45	29.01	22.78		1.86	C0180-029-1750S		1.55
C0180-029-2000M			50.80	33.07	25.83		1.61	C0180-029-2000S		1.34
C0180-032-0310M			7.87	6.05	5.23		21.49	C0180-032-0310S		17.90
C0180-032-0380M			9.65	7.34	6.10		16.99	C0180-032-0380S		14.15
C0180-032-0440M			11.18	8.28	7.11		13.57	C0180-032-0440S		11.30
C0180-032-0500M			12.70	9.25	8.10		11.36	C0180-032-0500S		9.46
C0180-032-0560M			14.22	10.41	8.71		10.31	C0180-032-0560S		8.59
C0180-032-0620M			15.75	11.38	9.70		8.98	C0180-032-0620S		7.48
C0180-032-0690M			17.53	12.80	10.31		8.32	C0180-032-0690S		6.93
C0180-032-0750M			19.05	13.61	11.58		7.23	C0180-032-0750S		6.02
C0180-032-0810M		0.81	20.57	14.55	12.60	39.28	6.53	C0180-032-0810S	32.72	5.44
C0180-032-0880M			22.35	15.65	13.79		5.87	C0180-032-0880S		4.89
C0180-032-0940M			23.88	16.71	14.63		5.48	C0180-032-0940S		4.56
C0180-032-1000M			25.40	17.78	15.44		5.15	C0180-032-1000S		4.29
C0180-032-1120M			28.45	19.69	17.20		4.48	C0180-032-1120S		3.73
C0180-032-1250M			31.75	21.92	19.00		3.99	C0180-032-1250S		3.32
C0180-032-1380M			35.05	24.16	20.80		3.61	C0180-032-1380S		3.01
C0180-032-1500M			38.10	26.16	22.48		3.29	C0180-032-1500S		2.74
C0180-032-1750M			44.45	30.53	25.98		2.82	C0180-032-1750S		2.35
C0180-032-2000M			50.80	34.77	29.46		2.45	C0180-032-2000S		2.04
C0180-035-0380M			9.65	7.67	7.26		23.99	C0180-035-0380S		19.98
C0180-035-0440M			11.18	8.79	8.15		20.08	C0180-035-0440S		16.73
C0180-035-0500M			12.70	9.93	9.04		17.28	C0180-035-0500S		14.39
C0180-035-0560M			14.22	11.07	9.93		15.16	C0180-035-0560S		12.63
C0180-035-0620M			15.75	12.22	10.82		13.52	C0180-035-0620S		11.26
C0180-035-0690M			17.53	13.54	11.86		11.99	C0180-035-0690S		9.99
C0180-035-0750M		0.89	19.05	14.68	12.75	47.77	10.93	C0180-035-0750S	39.79	9.10
C0180-035-0810M			20.57	15.82	13.64		10.05	C0180-035-0810S		8.37
C0180-035-0880M			22.35	17.15	14.68		9.18	C0180-035-0880S		7.65
C0180-035-0940M			23.88	18.29	15.57		8.55	C0180-035-0940S		7.12
C0180-035-1000M			25.40	19.43	16.46		8.00	C0180-035-1000S		6.66
C0180-035-1120M			28.45	21.69	18.24		7.07	C0180-035-1120S		5.89
C0180-035-1250M			31.75	24.16	20.14		6.30	C0180-035-1250S		5.25

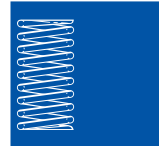

COMPRESSION SPRINGS - MUSIC WIRE								STAINLESS STEEL / INOX		
Part Number	Do (mm)	d (mm)	Lo (mm)	L ₁ (mm)	Sh (mm)	P ₁ (N)	R (N/mm)	Part Number	P ₁ (N)	R (N/mm)
C0180-035-1500M			38.10	28.91	23.85		5.20	C0180-035-1500S		4.33
C0180-035-1750M		0.89	44.45	33.66	27.56	47.77	4.43	C0180-035-1750S	39.79	3.69
C0180-035-2000M			50.80	38.40	31.27		3.85	C0180-035-2000S		3.21
D11400			6.70	4.30	4.10		7.16	D21400		5.96
D11410			9.60	5.80	5.36		4.55	D21410		3.79
D11420		0.63	14.00	8.20	7.25	17.16	2.94	D21420	14.29	2.45
D11430			20.00	11.30	9.77		2.00	D21430		1.67
D11440	4.57		29.00	16.20	13.55		1.35	D21440		1.12
D11600			6.90	5.20	5.20		18.53	D21600		15.44
D11610			9.70	7.00	6.80		11.87	D21610		9.89
D11620		0.80	14.00	9.80	9.20	31.87	7.67	D21620	26.55	6.39
D11630			19.50	13.50	12.40		5.22	D21630		4.35
D11640			28.00	19.10	17.20		3.52	D21640		2.93
C0210-018-0250M			6.35	2.90	2.26		1.93	C0210-018-0250S		1.60
C0210-018-0310M			7.87	3.43	2.51		1.51	C0210-018-0310S		1.25
C0210-018-0380M			9.65	4.09	2.79		1.19	C0210-018-0380S		0.99
C0210-018-0440M			11.18	4.62	3.05		1.02	C0210-018-0440S		0.85
C0210-018-0500M			12.70	5.18	3.30		0.89	C0210-018-0500S		0.74
C0210-018-0560M			14.22	5.74	3.56		0.79	C0210-018-0560S		0.66
C0210-018-0620M			15.75	6.30	3.81		0.70	C0210-018-0620S		0.58
C0210-018-0690M		0.46	17.53	6.93	4.09	6.67	0.63	C0210-018-0690S	5.56	0.52
C0210-018-0750M			19.05	7.49	4.34		0.58	C0210-018-0750S		0.48
C0210-018-0810M			20.57	7.87	4.60		0.53	C0210-018-0810S		0.44
C0210-018-0880M			22.35	8.69	4.88		0.49	C0210-018-0880S		0.41
C0210-018-1000M			25.40	9.53	5.38		0.42	C0210-018-1000S		0.35
C0210-018-1250M			31.75	11.71	6.43		0.33	C0210-018-1250S		0.28
C0210-018-1500M			38.10	14.38	7.47		0.28	C0210-018-1500S		0.23
C0210-018-1750M			44.45	17.25	8.48		0.25	C0210-018-1750S		0.20
C0210-018-2000M			50.80	19.00	9.53		0.21	C0210-018-2000S		0.17
C0210-022-0250M			6.35	3.56	2.87		4.13	C0210-022-0250S		3.44
C0210-022-0310M			7.87	4.27	3.23		3.20	C0210-022-0310S		2.67
C0210-022-0380M			9.65	5.11	3.63		2.54	C0210-022-0380S		2.12
C0210-022-0440M			11.18	5.82	3.99		2.15	C0210-022-0440S		1.79
C0210-022-0500M			12.70	6.53	4.32		1.87	C0210-022-0500S		1.56
C0210-022-0560M			14.22	7.24	4.67		1.65	C0210-022-0560S		1.37
C0210-022-0620M			15.75	7.98	5.03		1.49	C0210-022-0620S		1.24
C0210-022-0690M		0.56	17.53	8.79	5.44	11.52	1.31	C0210-022-0690S	9.60	1.09
C0210-022-0750M			19.05	9.50	5.79		1.21	C0210-022-0750S		1.01
C0210-022-0810M	5.33		20.57	10.21	6.12		1.12	C0210-022-0810S		0.93
C0210-022-0880M			22.35	11.05	6.53		1.02	C0210-022-0880S		0.85
C0210-022-1000M			25.40	12.47	7.24		0.89	C0210-022-1000S		0.74
C0210-022-1250M			31.75	15.44	8.69		0.70	C0210-022-1250S		0.58
C0210-022-1500M			38.10	18.16	10.13		0.58	C0210-022-1500S		0.48
C0210-022-1750M			44.45	21.77	11.58		0.51	C0210-022-1750S		0.42
C0210-022-2000M			50.80	24.36	13.06		0.44	C0210-022-2000S		0.36
C0210-026-0250M			6.35	3.96	3.56		7.72	C0210-026-0250S		6.43
C0210-026-0310M			7.87	4.78	4.04		5.94	C0210-026-0310S		4.95
C0210-026-0380M			9.65	5.72	4.60		4.66	C0210-026-0380S		3.88
C0210-026-0440M			11.18	6.50	5.08		3.94	C0210-026-0440S		3.28
C0210-026-0500M			12.70	7.32	5.56		3.41	C0210-026-0500S		2.84
C0210-026-0560M			14.22	8.13	6.02		3.01	C0210-026-0560S		2.51
C0210-026-0620M			15.75	8.92	6.50		2.70	C0210-026-0620S		2.25
C0210-026-0690M		0.66	17.53	9.86	7.06	18.42	2.40	C0210-026-0690S	15.34	2.00
C0210-026-0750M			19.05	10.67	7.54		2.19	C0210-026-0750S		1.82
C0210-026-0810M			20.57	11.46	8.03		2.01	C0210-026-0810S		1.67
C0210-026-0880M			22.35	12.40	8.59		1.84	C0210-026-0880S		1.53
C0210-026-1000M			25.40	14.00	9.55		1.61	C0210-026-1000S		1.34
C0210-026-1250M			31.75	17.35	11.53		1.28	C0210-026-1250S		1.06
C0210-026-1500M			38.10	20.68	13.54		1.05	C0210-026-1500S		0.88
C0210-026-1750M			44.45	24.03	15.52		0.89	C0210-026-1750S		0.74
C0210-026-2000M			50.80	27.38	17.50		0.79	C0210-026-2000S		0.66
D11050			10.50	3.20	2.60		0.60	D21050		0.50
D11060			16.00	4.50	3.40		0.38	D21060		0.32
D11070	5.40	0.40	24.00	6.40	4.60	4.36	0.25	D21070	3.63	0.21
D11080			35.00	9.00	6.20		0.17	D21080		0.14
D11090			53.00	12.80	8.60		0.11	D21090		0.09
D11250			9.40	3.90	3.25		1.46	D21250		1.22
D11260			14.00	5.40	4.25		0.93	D21260		0.77
D11270	5.50	0.50	20.50	7.60	5.75	8.04	0.61	D21270	6.70	0.51
D11280			30.00	10.60	7.75		0.41	D21280		0.34
D11290			44.50	15.10	10.75		0.27	D21290		0.22

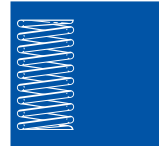

COMPRESSION SPRINGS - MUSIC WIRE								STAINLESS STEEL / INOX		
Part Number	Do (mm)	d (mm)	Lo (mm)	L ₁ (mm)	Sh (mm)	P ₁ (N)	R (N/mm)	Part Number	P ₁ (N)	R (N/mm)
D11450			8.50	4.30	4.10		3.69	D21450		3.07
D11460			12.50	5.80	5.36		2.35	D21460		1.96
D11470	5.63	0.63	18.50	8.20	7.25	15.49	1.55	D21470	12.90	1.29
D11480			26.00	11.30	9.77		1.03	D21480		0.86
D11490			38.50	16.20	13.55		0.70	D21490		0.58
D11650			8.30	5.60	5.20		9.53	D21650		7.94
D11660			12.00	7.70	6.80		6.07	D21660		5.06
D11670	5.80	0.80	17.50	10.90	9.20	25.99	3.92	D21670	21.65	3.27
D11680			24.50	15.10	12.40		2.67	D21680		2.22
D11690			36.00	21.50	17.20		1.80	D21690		1.50
D11850			8.50	6.60	5.50		23.24	D21850		19.36
D11860			12.00	9.00	7.50		14.81	D21860		12.34
D11870	6.00	1.00	17.00	12.60	10.50	43.74	9.57	D21870	36.44	7.97
D11880			24.00	17.40	14.50		6.51	D21880		5.42
D11890			34.50	24.60	20.50		4.40	D21890		3.67
C0240-016-0250M			6.35	2.59	1.78		1.09	C0240-016-0250S		0.90
C0240-016-0310M			7.87	3.02	1.93		0.84	C0240-016-0310S		0.70
C0240-016-0380M			9.65	3.66	2.11		0.68	C0240-016-0380S		0.57
C0240-016-0440M			11.18	4.06	2.26		0.58	C0240-016-0440S		0.48
C0240-016-0500M			12.70	4.65	2.41		0.51	C0240-016-0500S		0.42
C0240-016-0560M			14.22	4.88	2.57		0.44	C0240-016-0560S		0.36
C0240-016-0620M			15.75	5.51	2.72		0.40	C0240-016-0620S		0.34
C0240-016-0690M		0.41	17.53	5.84	2.90	4.09	0.35	C0240-016-0690S	3.41	0.29
C0240-016-0750M			19.05	6.76	3.05		0.33	C0240-016-0750S		0.28
C0240-016-0810M			20.57	6.83	3.20		0.30	C0240-016-0810S		0.25
C0240-016-0880M			22.35	7.75	3.38		0.28	C0240-016-0880S		0.23
C0240-016-1000M			25.40	8.71	3.68		0.25	C0240-016-1000S		0.20
C0240-016-1250M			31.75	10.54	4.32		0.19	C0240-016-1250S		0.16
C0240-016-1500M			38.10	12.14	4.95		0.16	C0240-016-1500S		0.13
C0240-016-1750M			44.45	15.24	5.59		0.14	C0240-016-1750S		0.12
C0240-016-2000M			50.80	17.42	6.22		0.12	C0240-016-2000S		0.10
C0240-018-0250M			6.35	2.92	2.03		1.66	C0240-018-0250S		1.39
C0240-018-0310M			7.87	3.48	2.24		1.30	C0240-018-0310S		1.08
C0240-018-0380M			9.65	4.11	2.44		1.03	C0240-018-0380S		0.86
C0240-018-0440M			11.18	4.67	2.62		0.88	C0240-018-0440S		0.73
C0240-018-0500M			12.70	5.31	2.82		0.77	C0240-018-0500S		0.64
C0240-018-0560M			14.22	5.89	3.00		0.68	C0240-018-0560S		0.57
C0240-018-0620M			15.75	6.38	3.20		0.61	C0240-018-0620S		0.51
C0240-018-0690M		0.46	17.53	7.01	3.40	5.69	0.54	C0240-018-0690S	4.74	0.45
C0240-018-0750M			19.05	7.44	3.58		0.49	C0240-018-0750S		0.41
C0240-018-0810M			20.57	8.13	3.78		0.46	C0240-018-0810S		0.38
C0240-018-0880M			22.35	8.79	3.99		0.42	C0240-018-0880S		0.35
C0240-018-1000M			25.40	9.91	4.37		0.37	C0240-018-1000S		0.31
C0240-018-1250M	6.10		31.75	12.62	5.16		0.30	C0240-018-1250S		0.25
C0240-018-1500M			38.10	14.88	5.92		0.25	C0240-018-1500S		0.20
C0240-018-1750M			44.45	17.35	6.71		0.21	C0240-018-1750S		0.17
C0240-018-2000M			50.80	18.29	7.47		0.18	C0240-018-2000S		0.15
C0240-020-0250M			6.35	3.20	2.31		2.47	C0240-020-0250S		2.06
C0240-020-0310M			7.87	3.84	2.51		1.93	C0240-020-0310S		1.60
C0240-020-0380M			9.65	4.57	2.79		1.52	C0240-020-0380S		1.27
C0240-020-0440M			11.18	5.18	3.00		1.30	C0240-020-0440S		1.08
C0240-020-0500M			12.70	5.82	3.23		1.12	C0240-020-0500S		0.93
C0240-020-0560M			14.22	6.45	3.45		1.00	C0240-020-0560S		0.83
C0240-020-0620M			15.75	7.06	3.68		0.89	C0240-020-0620S		0.74
C0240-020-0690M		0.51	17.53	7.80	3.94	7.78	0.81	C0240-020-0690S	6.48	0.67
C0240-020-0750M			19.05	8.43	4.17		0.74	C0240-020-0750S		0.61
C0240-020-0810M			20.57	8.86	4.37		0.67	C0240-020-0810S		0.55
C0240-020-0880M			22.35	9.65	4.62		0.61	C0240-020-0880S		0.51
C0240-020-1000M			25.40	11.02	5.08		0.54	C0240-020-1000S		0.45
C0240-020-1250M			31.75	13.23	5.99		0.42	C0240-020-1250S		0.35
C0240-020-1500M			38.10	15.88	6.93		0.35	C0240-020-1500S		0.29
C0240-020-1750M			44.45	18.31	7.85		0.30	C0240-020-1750S		0.25
C0240-020-2000M			50.80	21.16	8.79		0.26	C0240-020-2000S		0.22
C0240-022-0250M			6.35	3.23	2.62		3.41	C0240-022-0250S		2.84
C0240-022-0310M			7.87	3.86	2.87		2.64	C0240-022-0310S		2.20
C0240-022-0380M			9.65	4.72	2.92		2.15	C0240-022-0380S		1.79
C0240-022-0440M		0.56	11.18	4.90	3.33	10.63	1.70	C0240-022-0440S	8.85	1.41
C0240-022-0500M			12.70	5.54	3.61		1.49	C0240-022-0500S		1.24
C0240-022-0560M			14.22	6.15	3.91		1.31	C0240-022-0560S		1.09
C0240-022-0620M			15.75	6.78	4.17		1.19	C0240-022-0620S		0.99
C0240-022-0690M			17.53	7.67	4.45		1.09	C0240-022-0690S		0.90

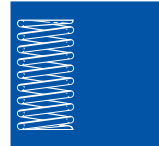

COMPRESSION SPRINGS - MUSIC WIRE								STAINLESS STEEL / INOX		
Part Number	Do (mm)	d (mm)	Lo (mm)	L ₁ (mm)	Sh (mm)	P ₁ (N)	R (N/mm)	Part Number	P ₁ (N)	R (N/mm)
C0240-022-0750M			19.05	8.31	4.78		0.98	C0240-022-0750S		0.82
C0240-022-0810M			20.57	8.94	5.03		0.91	C0240-022-0810S		0.76
C0240-022-1000M			25.40	10.95	5.99		0.74	C0240-022-1000S		0.61
C0240-022-1250M		0.56	31.75	13.36	7.11	10.63	0.58	C0240-022-1250S	8.85	0.48
C0240-022-1500M			38.10	16.41	8.26		0.49	C0240-022-1500S		0.41
C0240-022-1750M			44.45	19.15	9.37		0.42	C0240-022-1750S		0.35
C0240-022-2000M			50.80	21.89	10.49		0.37	C0240-022-2000S		0.31
C0240-024-0380M			9.65	5.05	3.61		2.84	C0240-024-0380S		2.37
C0240-024-0440M			11.18	5.77	3.94		2.40	C0240-024-0440S		2.00
C0240-024-0500M			12.70	6.45	4.27		2.08	C0240-024-0500S		1.73
C0240-024-0560M			14.22	7.16	4.57		1.84	C0240-024-0560S		1.53
C0240-024-0620M			15.75	7.85	4.90		1.65	C0240-024-0620S		1.37
C0240-024-0690M			17.53	8.66	5.28		1.47	C0240-024-0690S		1.23
C0240-024-0750M		0.61	19.05	9.35	5.61	12.99	1.33	C0240-024-0750S	10.82	1.11
C0240-024-0810M			20.57	10.06	5.92		1.23	C0240-024-0810S		1.02
C0240-024-0880M			22.35	10.85	6.30		1.12	C0240-024-0880S		0.93
C0240-024-1000M			25.40	12.24	6.96		0.98	C0240-024-1000S		0.82
C0240-024-1250M			31.75	15.14	8.31		0.79	C0240-024-1250S		0.66
C0240-024-1500M			38.10	18.03	9.63		0.65	C0240-024-1500S		0.54
C0240-024-1750M			44.45	21.29	10.97		0.56	C0240-024-1750S		0.47
C0240-024-2000M			50.80	23.34	12.32		0.47	C0240-024-2000S		0.39
C0240-026-0310M			7.87	4.47	3.51		5.03	C0240-026-0310S		4.19
C0240-026-0380M			9.65	5.46	3.63		4.08	C0240-026-0380S		3.40
C0240-026-0440M			11.18	6.27	3.96		3.48	C0240-026-0440S		2.90
C0240-026-0500M			12.70	7.09	4.29		3.05	C0240-026-0500S		2.54
C0240-026-0560M			14.22	7.57	4.78		2.57	C0240-026-0560S		2.14
C0240-026-0620M			15.75	8.05	5.28		2.22	C0240-026-0620S		1.85
C0240-026-0690M			17.53	8.76	5.79		1.94	C0240-026-0690S		1.62
C0240-026-0750M		0.66	19.05	9.25	6.25	17.13	1.75	C0240-026-0750S	14.27	1.46
C0240-026-0810M			20.57	10.06	6.60		1.63	C0240-026-0810S		1.36
C0240-026-0880M			22.35	10.80	7.14		1.47	C0240-026-0880S		1.23
C0240-026-1000M			25.40	12.19	7.95		1.30	C0240-026-1000S		1.08
C0240-026-1250M			31.75	15.16	9.53		1.03	C0240-026-1250S		0.86
C0240-026-1500M			38.10	18.14	11.10		0.86	C0240-026-1500S		0.71
C0240-026-1750M			44.45	20.60	12.67		0.72	C0240-026-1750S		0.60
C0240-026-2000M	6.10		50.80	23.65	14.25		0.63	C0240-026-2000S		0.52
C0240-029-0380M			9.65	5.72	4.70		5.60	C0240-029-0380S		4.66
C0240-029-0440M			11.18	6.53	5.16		4.73	C0240-029-0440S		3.94
C0240-029-0500M			12.70	7.32	5.61		4.08	C0240-029-0500S		3.40
C0240-029-0560M			14.22	8.10	6.10		3.61	C0240-029-0560S		3.01
C0240-029-0620M			15.75	8.89	6.55		3.22	C0240-029-0620S		2.68
C0240-029-0690M			17.53	9.83	7.09		2.85	C0240-029-0690S		2.37
C0240-029-0750M			19.05	10.62	7.57		2.61	C0240-029-0750S		2.17
C0240-029-0810M			20.57	11.40	8.03		2.40	C0240-029-0810S		2.00
C0240-029-0880M		0.74	22.35	12.32	8.56	22.02	2.21	C0240-029-0880S	18.34	1.84
C0240-029-0940M			23.88	13.13	9.02		2.05	C0240-029-0940S		1.71
C0240-029-1000M			25.40	13.92	9.50		1.93	C0240-029-1000S		1.60
C0240-029-1120M			28.45	15.49	10.41		1.70	C0240-029-1120S		1.41
C0240-029-1250M			31.75	17.22	11.43		1.52	C0240-029-1250S		1.27
C0240-029-1380M			35.05	18.92	12.42		1.37	C0240-029-1380S		1.14
C0240-029-1500M			38.10	20.52	13.36		1.26	C0240-029-1500S		1.05
C0240-029-1750M			44.45	23.83	15.29		1.07	C0240-029-1750S		0.89
C0240-029-2000M			50.80	27.13	17.22		0.93	C0240-029-2000S		0.77
C0240-032-0310M			7.87	5.13	4.24		11.17	C0240-032-0310S		9.30
C0240-032-0380M			9.65	6.40	4.67		9.42	C0240-032-0380S		7.85
C0240-032-0440M			11.18	7.16	5.31		7.56	C0240-032-0440S		6.30
C0240-032-0500M			12.70	7.95	5.89		6.44	C0240-032-0500S		5.36
C0240-032-0560M			14.22	8.74	6.48		5.59	C0240-032-0560S		4.66
C0240-032-0620M			15.75	9.50	7.09		4.90	C0240-032-0620S		4.08
C0240-032-0690M			17.53	10.52	7.70		4.38	C0240-032-0690S		3.65
C0240-032-0750M			19.05	11.05	8.51		3.84	C0240-032-0750S		3.20
C0240-032-0810M		0.81	20.57	11.84	9.12	30.65	3.50	C0240-032-0810S	25.53	2.92
C0240-032-0880M			22.35	12.85	9.75		3.22	C0240-032-0880S		2.68
C0240-032-0940M			23.88	13.64	10.34		2.99	C0240-032-0940S		2.49
C0240-032-1000M			25.40	14.40	10.95		2.78	C0240-032-1000S		2.32
C0240-032-1250M			31.75	17.75	13.36		2.19	C0240-032-1250S		1.82
C0240-032-1380M			35.05	19.43	14.55		1.96	C0240-032-1380S		1.63
C0240-032-1500M			38.10	21.11	15.65		1.80	C0240-032-1500S		1.50
C0240-032-1750M			44.45	24.56	17.96		1.54	C0240-032-1750S		1.28
C0240-032-2000M			50.80	27.76	20.24		1.33	C0240-032-2000S		1.11
C0240-035-0310M		0.89	7.87	5.44	5.23	37.10	15.22	C0240-035-0310S	30.90	12.68

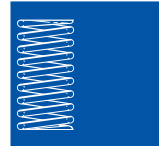

COMPRESSION SPRINGS - MUSIC WIRE								STAINLESS STEEL / INOX		
Part Number	Do (mm)	d (mm)	Lo (mm)	L ₁ (mm)	Sh (mm)	P ₁ (N)	R (N/mm)	Part Number	P ₁ (N)	R (N/mm)
C0240-035-0380M			9.65	6.50	5.97		11.78	C0240-035-0380S		9.81
C0240-035-0440M			11.18	7.42	6.60		9.88	C0240-035-0440S		8.23
C0240-035-0500M			12.70	8.33	7.26		8.49	C0240-035-0500S		7.07
C0240-035-0560M			14.22	9.25	7.90		7.46	C0240-035-0560S		6.21
C0240-035-0620M			15.75	10.16	8.53		6.64	C0240-035-0620S		5.53
C0240-035-0690M			17.53	11.23	9.30		5.88	C0240-035-0690S		4.90
C0240-035-0750M			19.05	12.14	9.93		5.38	C0240-035-0750S		4.48
C0240-035-0810M			20.57	13.06	10.57		4.94	C0240-035-0810S		4.12
C0240-035-0880M			22.35	14.12	11.30		4.50	C0240-035-0880S		3.75
C0240-035-0940M		0.89	23.88	15.04	11.96	37.10	4.20	C0240-035-0940S	30.90	3.50
C0240-035-1000M			25.40	15.95	12.60		3.92	C0240-035-1000S		3.27
C0240-035-1250M			31.75	19.76	15.27		3.10	C0240-035-1250S		2.58
C0240-035-1380M			35.05	21.74	16.66		2.78	C0240-035-1380S		2.32
C0240-035-1500M			38.10	23.57	17.93		2.56	C0240-035-1500S		2.13
C0240-035-1750M			44.45	27.38	20.60		2.17	C0240-035-1750S		1.81
C0240-035-2000M			50.80	31.19	23.27		1.89	C0240-035-2000S		1.58
C0240-035-2250M			57.15	35.00	25.93		1.68	C0240-035-2250S		1.40
C0240-035-2500M			63.50	38.81	28.60		1.51	C0240-035-2500S		1.25
C0240-038-0310M			7.87	5.66	5.28		22.26	C0240-038-0310S		18.54
C0240-038-0380M			9.65	6.88	6.02		17.77	C0240-038-0380S		14.80
C0240-038-0440M			11.18	7.85	6.73		14.78	C0240-038-0440S		12.31
C0240-038-0500M			12.70	8.81	7.47		12.66	C0240-038-0500S		10.55
C0240-038-0560M			14.22	9.78	8.20		11.07	C0240-038-0560S		9.22
C0240-038-0620M			15.75	10.77	8.89		9.88	C0240-038-0620S		8.23
C0240-038-0690M			17.53	11.99	9.63		8.88	C0240-038-0690S		7.40
C0240-038-0750M			19.05	12.95	10.34		8.07	C0240-038-0750S		6.72
C0240-038-0810M			20.57	13.92	11.07		7.39	C0240-038-0810S		6.16
C0240-038-0880M		0.97	22.35	14.96	12.04	49.20	6.65	C0240-038-0880S	40.98	5.54
C0240-038-0940M			23.88	15.75	12.98		6.06	C0240-038-0940S		5.05
C0240-038-1000M			25.40	16.71	13.74		5.66	C0240-038-1000S		4.71
C0240-038-1120M			28.45	18.67	15.16		5.03	C0240-038-1120S		4.19
C0240-038-1250M			31.75	20.85	16.59		4.52	C0240-038-1250S		3.77
C0240-038-1380M			35.05	23.04	18.06		4.10	C0240-038-1380S		3.42
C0240-038-1500M			38.10	24.99	19.51		3.75	C0240-038-1500S		3.12
C0240-038-1750M			44.45	28.22	23.16		3.03	C0240-038-1750S		2.52
C0240-038-2000M	6.10		50.80	32.21	26.21		2.64	C0240-038-2000S		2.20
C0240-038-2250M			57.15	36.02	29.24		2.33	C0240-038-2250S		1.94
C0240-038-2500M			63.50	40.08	32.26		2.10	C0240-038-2500S		1.75
C0240-040-0310M			7.87	5.92	5.59		27.28	C0240-040-0310S		22.72
C0240-040-0380M			9.65	7.09	6.96		20.91	C0240-040-0380S		17.42
C0240-040-0440M			11.18	8.10	7.75		17.42	C0240-040-0440S		14.51
C0240-040-0500M			12.70	9.12	8.53		14.94	C0240-040-0500S		12.45
C0240-040-0560M			14.22	10.13	9.30		13.08	C0240-040-0560S		10.90
C0240-040-0620M			15.75	11.15	10.08		11.63	C0240-040-0620S		9.69
C0240-040-0690M			17.53	12.32	11.00		10.28	C0240-040-0690S		8.56
C0240-040-0750M			19.05	13.34	11.79		9.37	C0240-040-0750S		7.81
C0240-040-0810M			20.57	14.35	12.57		8.60	C0240-040-0810S		7.16
C0240-040-0880M		1.02	22.35	15.52	13.49	53.51	7.84	C0240-040-0880S	44.57	6.53
C0240-040-0940M			23.88	16.54	14.27		7.30	C0240-040-0940S		6.08
C0240-040-1000M			25.40	17.55	15.04		6.83	C0240-040-1000S		5.69
C0240-040-1120M			28.45	19.58	16.61		6.04	C0240-040-1120S		5.03
C0240-040-1250M			31.75	21.77	18.31		5.36	C0240-040-1250S		4.46
C0240-040-1380M			35.05	23.98	20.02		4.83	C0240-040-1380S		4.02
C0240-040-1500M			38.10	25.98	21.56		4.41	C0240-040-1500S		3.67
C0240-040-1750M			44.45	30.20	24.82		3.77	C0240-040-1750S		3.14
C0240-040-2000M			50.80	34.42	28.09		3.27	C0240-040-2000S		2.72
C0240-040-2250M			57.15	38.66	35.99		2.89	C0240-040-2250S		2.41
C0240-040-2500M			63.50	42.88	34.62		2.59	C0240-040-2500S		2.16
C0240-042-0380M			9.65	7.24	6.91		26.44	C0240-042-0380S		22.02
C0240-042-0440M			11.18	8.20	7.87		21.54	C0240-042-0440S		17.94
C0240-042-0500M			12.70	9.27	8.71		18.56	C0240-042-0500S		15.46
C0240-042-0560M			14.22	10.34	9.47		16.46	C0240-042-0560S		13.71
C0240-042-0620M			15.75	11.46	10.19		14.88	C0240-042-0620S		12.40
C0240-042-0690M			17.53	12.65	11.20		13.13	C0240-042-0690S		10.94
C0240-042-0750M		1.07	19.05	13.39	12.67	64.01	11.21	C0240-042-0750S	53.32	9.34
C0240-042-0810M			20.57	14.45	13.34		10.51	C0240-042-0810S		8.75
C0240-042-0880M			22.35	15.77	14.12		9.81	C0240-042-0880S		8.17
C0240-042-0940M			23.88	16.69	15.24		8.93	C0240-042-0940S		7.44
C0240-042-1000M			25.40	17.75	16.03		8.41	C0240-042-1000S		7.01
C0240-042-1120M			28.45	19.89	17.75		7.44	C0240-042-1120S		6.20
C0240-042-1250M			31.75	22.05	19.76		6.57	C0240-042-1250S		5.47

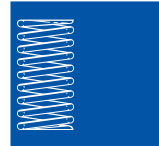

COMPRESSION SPRINGS - MUSIC WIRE								STAINLESS STEEL / INOX		
Part Number	Do (mm)	d (mm)	Lo (mm)	L ₁ (mm)	Sh (mm)	P ₁ (N)	R (N/mm)	Part Number	P ₁ (N)	R (N/mm)
C0240-042-1380M			35.05	24.33	21.51		5.95	C0240-042-1380S		4.96
C0240-042-1500M			38.10	26.11	23.70		5.34	C0240-042-1500S		4.45
C0240-042-1750M			44.45	30.66	26.42		4.64	C0240-042-1750S		3.87
C0240-042-2000M		1.07	50.80	34.90	29.90	64.01	4.03	C0240-042-2000S	53.32	3.36
C0240-042-2250M			57.15	39.24	33.38		3.57	C0240-042-2250S		2.97
C0240-042-2500M			63.50	43.54	36.88		3.20	C0240-042-2500S		2.67
C0240-045-0440M			11.18	8.84	8.28		30.63	C0240-045-0440S		25.51
C0240-045-0500M			12.70	9.96	9.17		26.14	C0240-045-0500S		21.77
C0240-045-0560M			14.22	11.07	10.06		22.80	C0240-045-0560S		18.99
C0240-045-0620M	6.10		15.75	12.19	11.07		20.22	C0240-045-0620S		16.84
C0240-045-0690M			17.53	13.51	12.12		17.86	C0240-045-0690S		14.88
C0240-045-0750M			19.05	14.63	13.11		16.23	C0240-045-0750S		13.52
C0240-045-0810M			20.57	15.75	14.00		14.88	C0240-045-0810S		12.40
C0240-045-0880M		1.14	22.35	17.04	15.09	71.92	13.57	C0240-045-0880S	59.91	11.30
C0240-045-1000M			25.40	19.30	16.94		11.78	C0240-045-1000S		9.81
C0240-045-1250M			31.75	23.98	20.65		9.25	C0240-045-1250S		7.71
C0240-045-1500M			38.10	28.65	24.36		7.60	C0240-045-1500S		6.33
C0240-045-1750M			44.45	33.30	28.07		6.46	C0240-045-1750S		5.38
C0240-045-2000M			50.80	37.97	31.78		5.60	C0240-045-2000S		4.66
C0240-045-2250M			57.15	42.65	35.48		4.96	C0240-045-2250S		4.13
C0240-045-2500M			63.50	47.32	39.19		4.45	C0240-045-2500S		3.71
D11300			13.50	4.30	3.25		0.73	D21300		0.61
D11310			20.00	6.00	4.25		0.46	D21310		0.38
D11320	6.80	0.50	30.00	8.70	5.75	6.57	0.30	D21320	5.47	0.25
D11330			44.00	12.20	7.75		0.21	D21330		0.17
D11340			65.00	17.40	10.75		0.14	D21340		0.12
D11500			11.50	4.60	4.10		1.83	D21500		1.52
D11510			17.00	6.20	5.36		1.17	D21510		0.97
D11520	6.93	0.63	25.50	8.90	7.25	12.45	0.76	D21520	10.37	0.63
D11530			36.50	12.30	9.77		0.51	D21530		0.42
D11540			54.00	17.70	13.55		0.34	D21540		0.28
D11700			10.50	5.60	5.20		4.77	D21700		3.97
D11710			15.50	7.70	6.80		3.03	D21710		2.52
D11720	7.10	0.80	23.00	10.90	9.20	24.03	1.96	D21720	20.02	1.63
D11730			33.00	15.10	12.40		1.33	D21730		1.11
D11740			48.00	21.50	17.20		0.90	D21740		0.75
D11900			10.00	7.30	5.50		11.57	D21900		9.64
D11910			14.50	10.10	7.50		7.39	D21910		6.16
D11920	7.30	1.00	21.50	14.30	10.50	34.13	4.79	D21920	28.43	3.99
D11930			30.50	19.90	14.50		3.26	D21930		2.72
D11940			43.50	28.30	20.50		2.20	D21940		1.83
D12100			12.00	7.20	6.88		29.03	D22100		24.18
D12110			17.00	9.80	9.38		18.04	D22110		15.03
D12120	7.55	1.25	25.00	13.80	13.13	133.37	11.77	D22120	111.10	9.80
D12130			35.50	19.20	18.13		8.09	D22130		6.74
D12140			51.50	27.10	25.63		5.39	D22140		4.49
C0300-022-0380M			9.65	4.19	2.54		1.58	C0300-022-0380S		1.31
C0300-022-0440M			11.18	4.72	2.69		1.33	C0300-022-0440S		1.11
C0300-022-0500M			12.70	5.21	2.77		1.16	C0300-022-0500S		0.96
C0300-022-0560M			14.22	5.97	2.92		1.03	C0300-022-0560S		0.86
C0300-022-0620M			15.75	6.02	3.20		0.88	C0300-022-0620S		0.73
C0300-022-0690M			17.53	7.04	3.33		0.82	C0300-022-0690S		0.69
C0300-022-0750M			19.05	7.06	3.61		0.72	C0300-022-0750S		0.60
C0300-022-0810M		0.56	20.57	7.67	3.78	8.59	0.67	C0300-022-0810S	7.16	0.55
C0300-022-0880M			22.35	8.86	3.91		0.63	C0300-022-0880S		0.52
C0300-022-1000M			25.40	10.08	4.45		0.56	C0300-022-1000S		0.47
C0300-022-1250M			31.75	12.14	5.18		0.44	C0300-022-1250S		0.36
C0300-022-1500M			38.10	14.76	5.89		0.37	C0300-022-1500S		0.31
C0300-022-1750M	7.62		44.45	17.22	6.63		0.32	C0300-022-1750S		0.26
C0300-022-2000M			50.80	18.11	7.34		0.26	C0300-022-2000S		0.22
C0300-022-2250M			57.15	22.12	7.82		0.25	C0300-022-2250S		0.20
C0300-022-2500M			63.50	25.78	8.48		0.23	C0300-022-2500S		0.19
C0300-026-0440M			11.18	5.23	3.30		2.33	C0300-026-0440S		1.94
C0300-026-0500M			12.70	5.56	3.63		1.94	C0300-026-0500S		1.62
C0300-026-0560M			14.22	6.50	3.76		1.80	C0300-026-0560S		1.50
C0300-026-0620M			15.75	6.83	4.11		1.56	C0300-026-0620S		1.30
C0300-026-0690M		0.66	17.53	7.42	4.47	13.88	1.37	C0300-026-0690S	11.56	1.14
C0300-026-0750M			19.05	8.33	4.62		1.30	C0300-026-0750S		1.08
C0300-026-0810M			20.57	8.69	4.93		1.17	C0300-026-0810S		0.98
C0300-026-0880M			22.35	9.27	5.23		1.07	C0300-026-0880S		0.89
C0300-026-0940M			23.88	9.60	5.64		0.96	C0300-026-0940S		0.80

