

RESSORTS DE COMPRESSION HAUTE PERFORMANCE

Ces ressorts offrent des performances élevées, dans des dimensions non disponibles dans nos gammes Corde à Piano et Inox.

MATERIAUX

Selon la disponibilité du stock, les matériaux fournis sont le chrome vanadium ou le chrome silicium. Pas recommandé pour les applications où la température excède 220°C (425°F).

ENROULEMENT

Enroulement à droite (RH) ou à gauche (LH), comme indiqué sur le tableau suivant, afin de permettre l'usage des ressorts en tandem.

EXTREMITES

Les références commençant par C00168, C00170, C00186, C00200, C00257, C00309, C00347, C00395 ont les extrémités rapprochées uniquement. Les autres les ont rapprochées et meulées.

TOLERANCES DES DIAMETRES INT. & EXT.

Cette gamme est conçue pour travailler dans un logement et autour d'un axe, comme spécifié dans le tableau.

CHARGES ET RAIDEURS

La raideur n'est donnée que pour référence. La charge (P) à L_1 est +/-10%.

ETAT DE SURFACE

Finition standard huilée. Finitions spéciales sur demande.

INDEX DES MESURES

- Do = Diamètre extérieur
- d = Diamètre du fil
- Sh = Hauteur à bloc approx.
- Lo = Longueur libre
- L_1 = Longueur en charge
- P_1 = Charge à L_1
- R = Raideur
- a = Diamètre de logement
- b = Diamètre d'arbre

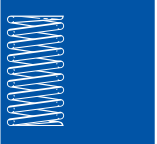
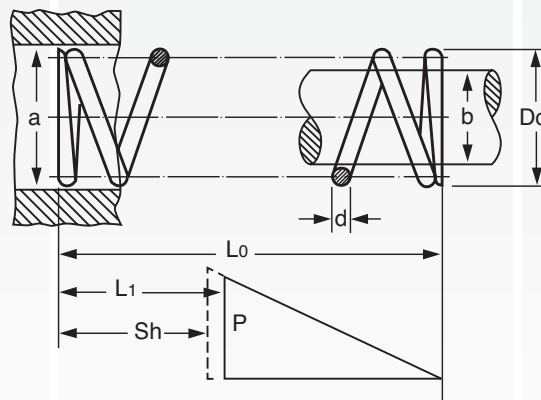

HIGH PERFORMANCE COMPRESSION SPRINGS

Part Number		Do (mm)	d (mm)	L (mm)	a (mm)	b (mm)	L ₁ (mm)	Sh (mm)	P ₁ (N)	R (N/mm)
C00168003003				3.2			2.2	1.6		2.5
C00168003004				4.0			2.8	2.0		2.0
C00168003005				5.0			3.4	2.5		1.5
C00168003006				6.3			4.3	3.1		1.2
C00168003008	LH	1.68	0.25	8.0		1.1	5.5	4.0	2.45	1.0
C00168003010				10.0			6.8	5.0		0.8
C00168003013				12.5			8.5	6.2		0.6
C00168003016				16.0			11.0	8.0		0.5
C00168003020				20.0			13.7	10.0		0.4
C00168003025				25.0	1.8		17.0	12.5		0.3
C00170003003				3.2			2.5	2.1		6.4
C00170003004				4.0			3.1	2.6		5.0
C00170003005				5.0			3.9	3.2		3.9
C00170003006				6.3			4.9	4.1		3.2
C00170003008	RH	1.70	0.32	8.0			6.2	5.2	4.41	2.5
C00170003010				10.0			7.7	6.4		1.9
C00170003013				12.5		1.0	9.7	8.0		1.6
C00170003016				16.0			12.5	10.4		1.3
C00170003020				20.0			15.6	13.0		1.0
C00170003025				25.0			19.3	16.0		0.8
C00186004010				10.0			8.3	7.3		4.6
C00186004013	LH	1.86	0.4	12.5			10.5	9.3	7.85	3.9
C00186004016				16.0			13.5	12.0		3.1
C00186004020				20.0			16.9	15.0		2.5
C00188003003				3.2			2.2	1.6		3.1
C00188003004				4.0			2.8	2.0		2.5
C00188003005				5.0			3.4	2.5		2.0
C00188003006				6.3			4.3	3.1		1.6
C00188003008	RH	1.88	0.28	8.0		1.3	5.5	4.0	3.14	1.3
C00188003010				10.0	2.0		6.8	5.0		1.0
C00188003013				12.5			8.5	6.2		0.8
C00188003016				16.0			11.0	8.0		0.6
C00188003020				20.0			13.7	10.0		0.5
C00188003025				25.0			17.0	12.5		0.4
C00190004010				10.0			7.7	6.4		2.4
C00190004013				12.5			9.7	8.0		1.9
C00190004016				16.0			12.5	10.4		1.6
C00190004020		1.90	0.36	20.0		1.1	15.6	13.0	5.49	1.2
C00190004025				25.0			19.3	16.0		1.0
C00190004032				32.0			24.9	20.8		0.8
C00190004040				40.0			31.2	26.0		0.6
C00200003006				6.3			3.9	2.5		0.9
C00200003008				8.0			5.0	3.2		0.7
C00200003010				10.0			6.2	4.0		0.6
C00200003013		2.00	0.25	12.5	2.1	1.4	7.7	5.0	2.16	0.4
C00200003016	LH			16.0			10.0	6.4		0.4
C00200003020				20.0			12.5	8.0		0.3
C00200003025				25.0			15.4	10.0		0.2
C00200003032				32.0			20.0	13.0		0.2
C00208005003				3.2			2.7	2.4		19.5
C00208005004				4.0			3.4	3.0		15.6
C00208005005				5.0			4.2	3.8		12.5
C00208005006				6.3			5.3	4.7		9.7
C00208005008		2.08	0.45	8.0		1.1	6.7	6.0	9.81	7.8
C00208005010				10.0			8.3	7.3		5.8
C00208005013				12.5			10.5	9.3		4.9
C00208005016				16.0			13.5	12.0		3.9
C00208005020				20.0			16.9	15.0		3.1
C00212004004				4.0			3.1	2.6		7.8
C00212004005				5.0	2.3		3.9	3.2		6.1
C00212004006				6.3			4.9	4.1		5.0
C00212004008				8.0			6.2	5.2		3.9
C00212004010				10.0			7.7	6.4		3.0
C00212004013		2.12	0.4	12.5		1.3	9.7	8.0	6.86	2.4
C00212004016	RH			16.0			12.5	10.4		1.9
C00212004020				20.0			15.6	13.0		1.6
C00212004025				25.0			19.3	16.0		1.2
C00212004032				32.0			24.9	20.8		1.0
C00212004040				40.0			31.2	26.0		0.8
C00214003003		2.14	0.32	3.2		1.4	2.2	1.6	3.92	3.9
C00214003004				4.0			2.8	2.0		3.1

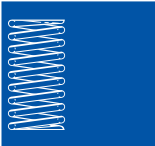

HIGH PERFORMANCE COMPRESSION SPRINGS

Part Number		Do (mm)	d (mm)	L (mm)	a (mm)	b (mm)	L ₁ (mm)	Sh (mm)	P ₁ (N)	R (N/mm)
C00214003005				5.0			3.4	2.5		2.5
C00214003006				6.3			4.3	3.1		2.0
C00214003008				8.0			5.5	4.0		1.6
C00214003010		2.14	0.32	10.0	2.3	1.4	6.8	5.0	3.92	1.2
C00214003013				12.5			8.5	6.2		1.0
C00214003016				16.0			11.0	8.0		0.8
C00214003020				20.0			13.7	10.0		0.6
C00214003025				25.0			17.0	12.5		0.5
C00232005004				4.0			3.4	3.0		19.5
C00232005005	RH			5.0			4.2	3.8		15.6
C00232005006				6.3			5.3	4.7		12.2
C00232005008				8.0			6.7	6.0		9.7
C00232005010		2.32	0.5	10.0		1.3	8.3	7.3	12.26	7.2
C00232005013				12.5			10.5	9.3		6.1
C00232005016				16.0			13.5	12.0		4.9
C00232005020				20.0			16.9	15.0		3.9
C00232005025				25.0			21.0	18.7		3.1
C00240003040				40.0			22.0	12.0		0.1
C00240003050			0.25	50.0	2.5	1.8	27.5	14.0	1.77	0.1
C00240003063				63.0			35.0	18.0		0.1
C00240005013				12.5			9.7	8.0		3.1
C00240005016		2.40		16.0			12.5	10.4		2.5
C00240005020	LH		0.45	20.0		1.4	15.6	13.0	8.83	2.0
C00240005025				25.0			19.3	16.0		1.6
C00240005032				32.0			24.9	20.8		1.3
C00240005040				40.0			31.2	26.0		1.0
C00242004003				3.2			2.2	1.6		4.9
C00242004004				4.0			2.8	2.0		3.9
C00242004005				5.0			3.4	2.5		3.1
C00242004006				6.3			4.3	3.1		2.5
C00242004008				8.0			5.5	4.0		2.0
C00242004010				10.0			6.8	5.0		1.5
C00242004013		2.42	0.36	12.5		1.6	8.5	6.2	4.90	1.2
C00242004016				16.0			11.0	8.0		1.0
C00242004020				20.0			13.7	10.0		0.8
C00242004025				25.0			17.0	12.5		0.6
C00242004032				32.0			22.0	16.0		0.5
C00242004040				40.0			27.5	20.0		0.4
C00242004050				50.0			34.0	25.0		0.3
C00257003008				8.0			5.0	3.2		1.2
C00257003010				10.0			6.2	4.0		0.9
C00257003013				12.5			7.7	5.0		0.7
C00257003016		2.57	0.32	16.0	2.7	1.8	10.0	6.4	3.53	0.6
C00257003020				20.0			12.5	8.0		0.5
C00257003025				25.0			15.4	10.0		0.4
C00257003032				32.0			20.0	13.0		0.3
C00257003040	RH			40.0			25.0	16.0		0.2
C00262005005				5.0			4.2	3.8		19.9
C00262005006				6.3			5.3	4.7		15.6
C00262005008				8.0			6.7	6.0		12.5
C00262005010		2.62	0.56	10.0	2.8	1.4	8.3	7.3	15.69	9.2
C00262005013				12.5			10.5	9.3		7.8
C00262005016				16.0			13.5	12.0		6.2
C00262005020				20.0			16.9	15.0		5.0
C00262005025				25.0			21.0	18.7		4.0
C00268003004				4.0			2.2	1.2		1.2
C00268003016				16.0			9.0	4.8		0.3
C00268003020				20.0			11.0	6.0		0.2
C00268003025		2.68	0.28	25.0		2.0	13.8	7.0	2.16	0.2
C00268003032				32.0			18.0	9.5		0.2
C00268003040				40.0			22.0	12.0		0.1
C00268003050				50.0			27.5	14.0		0.1
C00268003063				63.0			35.0	18.0		0.1
C00270004005				5.0			3.4	2.5		3.9
C00270004006				6.3			4.3	3.1		3.1
C00270004008				8.0			5.5	4.0		2.5
C00270004010		2.70	0.4	10.0		1.8	6.8	5.0	6.18	1.9
C00270004013				12.5			8.5	6.2		1.5
C00270004016				16.0			11.0	8.0		1.2
C00270004020				20.0			13.7	10.0		1.0
C00270004025				25.0			17.0	12.5		0.8

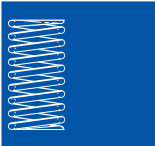

HIGH PERFORMANCE COMPRESSION SPRINGS

Part Number		Do (mm)	d (mm)	L (mm)	a (mm)	b (mm)	L ₁ (mm)	Sh (mm)	P ₁ (N)	R (N/mm)
C00270004032				32.0			22.0	16.0		0.6
C00270004040			0.4	40.0		1.8	27.5	20.0	6.18	0.5
C00270004050				50.0			34.0	25.0		0.4
C00270005005				5.0			3.9	3.2		9.5
C00270005006				6.3			4.9	4.1		7.8
C00270005008	RH	2.7		8.0	2.8		6.2	5.2		6.1
C00270005010				10.0			7.7	6.4		4.8
C00270005013			0.5	12.5		1.6	9.7	8.0	10.79	3.8
C00270005016				16.0			12.5	10.4		3.1
C00270005020				20.0			15.6	13.0		2.4
C00270005025				25.0			19.3	16.0		1.9
C00270005032				32.0			24.9	20.8		1.5
C00270005040				40.0			31.2	26.0		1.2
C00284004008		2.84	0.36	8.0	3.0	2.0	5.0	3.2	4.41	1.5
C00300003004				4.0			2.2	1.2		1.5
C00300003005				5.0			2.8	1.4		1.2
C00300003006				6.3			3.5	1.8		1.0
C00300003008				8.0			4.4	2.4		0.8
C00300003010				10.0			5.5	3.0		0.6
C00300003013				12.5			6.9	4.5		0.5
C00300003016			0.32	16.0		2.2	9.0	4.8	2.75	0.4
C00300003020				20.0			11.0	6.0		0.3
C00300003025				25.0			13.8	7.0		0.2
C00300003032				32.0			18.0	9.5		0.2
C00300003040				40.0			22.0	12.0		0.2
C00300003050				50.0			27.5	14.0		0.1
C00300003063				63.0			35.0	18.0		0.1
C00300005016		3.00		16.0	3.2		12.5	10.4		3.9
C00300005020				20.0			15.6	13.0		3.1
C00300005025			0.56	25.0		1.8	19.3	16.0	13.73	2.4
C00300005032				32.0			24.9	20.8		1.9
C00300005040	LH			40.0			31.2	26.0		1.6
C00300006005				5.0			4.2	3.8		24.9
C00300006006				6.3			5.3	4.7		19.5
C00300006008				8.0			6.7	6.0		15.6
C00300006010				10.0			8.3	7.3		11.5
C00300006013				12.5			10.5	9.3		9.7
C00300006016			0.63	16.0		1.6	13.5	12.0	19.61	7.8
C00300006020				20.0			16.9	15.0		6.2
C00300006025				25.0			21.0	18.7		4.9
C00300006032				32.0			27.0	24.0		3.9
C00300006040				40.0			33.7	30.0		3.1
C00300006050				50.0			42.1	37.5		2.5
C00300006063				63.0			52.9	47.0		1.9
C00309003010				10.0			5.0	2.0		0.2
C00309003013				12.5			6.2	2.5		0.2
C00309003016				16.0			8.0	3.2		0.2
C00309003020		3.09	0.25	20.0	3.3	2.5	10.0	4.0	1.23	0.1
C00309003025				25.0			12.5	5.0		0.1
C00309003032				32.0			16.0	6.4		0.1
C00309003040				40.0			20.0	8.0		0.1
C00320004010				10.0			6.2	4.0		1.4
C00320004013				12.5			7.7	5.0		1.1
C00320004016				16.0			10.0	6.4		0.9
C00320004020	RH	3.20	0.4	20.0	3.4	2.3	12.5	8.0	5.49	0.7
C00320004025				25.0			15.4	10.0		0.6
C00320004032				32.0			20.0	13.0		0.5
C00320004040				40.0			25.0	16.0		0.4
C00330007005				5.0			4.2	3.8		31.1
C00330007006				6.3			5.3	4.7		24.3
C00330007008				8.0			6.7	6.0		19.5
C00330007010				10.0			8.3	7.3		14.4
C00330007013				12.5			10.5	9.3		12.2
C00330007016		3.30	0.7	16.0	3.6	1.8	13.5	12.0	24.52	9.7
C00330007020	LH			20.0			16.9	15.0		7.8
C00330007025				25.0			21.0	18.7		6.2
C00330007032				32.0			27.0	24.0		4.9
C00330007040				40.0			33.7	30.0		3.9
C00330007050				50.0			42.1	37.5		3.1
C00330007063				63.0			52.9	47.0		2.4
C00332005006		3.32	0.5	6.3		2.3	4.3	3.1	9.81	4.9

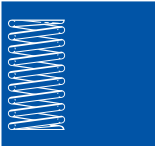

HIGH PERFORMANCE COMPRESSION SPRINGS

Part Number		Do (mm)	d (mm)	L (mm)	a (mm)	b (mm)	L ₁ (mm)	Sh (mm)	P ₁ (N)	R (N/mm)
C00332005008				8.0			5.5	4.0		3.9
C00332005010				10.0			6.8	5.0		3.1
C00332005013				12.5			8.5	6.2		2.5
C00332005016				16.0			11.0	8.0		2.0
C00332005020	LH	3.32	0.5	20.0		2.3	13.7	10.0	9.81	1.6
C00332005025				25.0			17.0	12.5		1.2
C00332005032				32.0			22.0	16.0		1.0
C00332005040				40.0			27.5	20.0		0.8
C00332005050				50.0			34.0	25.0		0.6
C00336006006				6.3			4.9	4.1		12.7
C00336006008				8.0			6.2	5.2		10.0
C00336006010				10.0			7.7	6.4		7.8
C00336006013				12.5			9.7	8.0		6.2
C00336006016				16.0			12.5	10.4		5.0
C00336006020	RH	3.36	0.63	20.0	3.6	2.0	15.6	13.0	17.65	4.0
C00336006025				25.0			19.3	16.0		3.1
C00336006032				32.0			24.9	20.8		2.5
C00336006040				40.0			31.2	26.0		2.0
C00336006050				50.0			38.7	32.0		1.6
C00336006063				63.0			48.8	40.5		1.2
C00337004005				5.0			2.8	1.4		1.6
C00337004006				6.3			3.5	1.8		1.3
C00337004008				8.0			4.4	2.4		1.0
C00337004010				10.0			5.5	3.0		0.8
C00337004013				12.5			6.9	4.5		0.6
C00337004016	LH	3.37	0.36	16.0		2.5	9.0	4.8	3.53	0.5
C00337004020				20.0			11.0	6.0		0.4
C00337004025				25.0			13.8	7.0		0.3
C00337004032				32.0			18.0	9.5		0.3
C00337004040				40.0			22.0	12.0		0.2
C00337004050				50.0			27.5	14.0		0.2
C00337004063				63.0			35.0	18.0		0.1
C00347003010				10.0			5.0	2.0		0.3
C00347003013				12.5			6.2	2.5		0.2
C00347003016				16.0			8.0	3.2		0.2
C00347003020		3.47	0.3	20.0	3.7	2.8	10.0	4.0	1.57	0.2
C00347003025				25.0			12.5	5.0		0.1
C00347003032				32.0			16.0	6.4		0.1
C00347003040				40.0			20.0	8.0		0.1
C00347003050	RH			50.0			25.0	10.0		0.1
C00355005013				12.5			7.7	5.0		1.4
C00355005016				16.0			10.0	6.4		1.1
C00355005020				20.0			12.5	8.0		0.9
C00355005025		3.55	0.45	25.0	3.8	2.5	15.4	10.0	6.86	0.7
C00355005032				32.0			20.0	13.0		0.6
C00355005040				40.0			25.0	16.0		0.5
C00355005050				50.0			31.0	20.0		0.4
C00355005063				63.0			39.0	25.0		0.3
C00376007032				32.0			24.9	20.8		3.1
C00376007040		3.76	0.7	40.0		2.3	31.2	26.0	22.07	2.5
C00376007050				50.0			38.7	32.0		1.9
C00376007063				63.0			48.8	40.5		1.6
C00377005006				6.3			4.3	3.1		6.1
C00377005008				8.0			5.5	4.0		4.9
C00377005010				10.0			6.8	5.0		3.8
C00377005013				12.5			8.5	6.2		3.1
C00377005016				16.0			11.0	8.0		2.5
C00377005020		3.77	0.56	20.0		2.5	13.7	10.0	12.26	1.9
C00377005025				25.0			17.0	12.5		1.5
C00377005032	LH			32.0	4.0		22.0	16.0		1.2
C00377005040				40.0			27.5	20.0		1.0
C00377005050				50.0			34.0	25.0		0.8
C00377005063				63.0			43.0	31.0		0.6
C00377005080				80.0			55.0	40.0		0.5
C00380004005				5.0			2.8	1.4		2.0
C00380004006				6.3			3.5	1.8		1.6
C00380004008				8.0			4.4	2.4		1.2
C00380004010		3.80	0.4	10.0		2.8	5.5	3.0	4.41	1.0
C00380004013				12.5			6.9	4.5		0.8
C00380004016				16.0			9.0	4.8		0.6
C00380004020				20.0			11.0	6.0		0.5

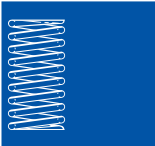

HIGH PERFORMANCE COMPRESSION SPRINGS

Part Number		Do (mm)	d (mm)	L (mm)	a (mm)	b (mm)	L ₁ (mm)	Sh (mm)	P ₁ (N)	R (N/mm)
C00380004025				25.0			13.8	7.0		0.4
C00380004032				32.0			18.0	9.5		0.3
C00380004040	LH	3.80	0.4	40.0	4.0	2.8	22.0	12.0	4.41	0.2
C00380004050				50.0			27.5	14.0		0.2
C00380004063				63.0			35.0	18.0		0.2
C00380004080				80.0			44.0	24.0		0.1
C00395003010				10.0			5.0	2.0		0.4
C00395003013				12.5			6.2	2.5		0.3
C00395003016				16.0			8.0	3.2		0.2
C00395003020	RH	3.95	0.32	20.0	4.3	3.2	10.0	4.0	1.96	0.2
C00395003025				25.0			12.5	5.0		0.2
C00395003032				32.0			16.0	6.4		0.1
C00395003040				40.0			20.0	8.0		0.1
C00395003050				50.0			25.0	10.0		0.1
C00400005013				12.5			7.7	5.0		1.8
C00400005016				16.0			10.0	6.4		1.5
C00400005020				20.0			12.5	8.0		1.2
C00400005025	LH	4.00	0.5	25.0	4.2	2.8	15.4	10.0	8.83	0.9
C00400005032				32.0			20.0	13.0		0.7
C00400005040				40.0			25.0	16.0		0.6
C00400005050				50.0			31.0	20.0		0.5
C00400005063				63.0			39.0	25.0		0.4
C00416009006				6.3			5.3	4.7		38.9
C00416009008				8.0			6.7	6.0		31.1
C00416009010				10.0			8.3	7.3		23.1
C00416009013				12.5			10.5	9.3		19.5
C00416009016				16.0			13.5	12.0		15.6
C00416009020		4.16	0.9	20.0		2.3	16.9	15.0	39.23	12.5
C00416009025				25.0			21.0	18.7		9.9
C00416009032				32.0			27.0	24.0		7.8
C00416009040				40.0			33.7	30.0		6.2
C00416009050				50.0			42.1	37.5		5.0
C00416009063				63.0			52.9	47.0		3.9
C00420005006				6.3			3.5	1.8		2.0
C00420005008				8.0			4.4	2.4		1.5
C00420005010				10.0			5.5	3.0		1.2
C00420005013				12.5			6.9	4.5		1.0
C00420005016				16.0			9.0	4.8		0.8
C00420005020	RH	4.20	0.45	20.0		3.2	11.0	6.0	5.49	0.6
C00420005025				25.0			13.8	7.0		0.5
C00420005032				32.0	4.5		18.0	9.5		0.4
C00420005040				40.0			22.0	12.0		0.3
C00420005050				50.0			27.5	14.0		0.2
C00420005063				63.0			35.0	18.0		0.2
C00420005080				80.0			44.0	24.0		0.2
C00425008006				6.3			4.9	4.1		19.8
C00425008008				8.0			6.2	5.2		15.6
C00425008010				10.0			7.7	6.4		12.1
C00425008013				12.5			9.7	8.0		9.7
C00425008016				16.0			12.5	10.4		7.8
C00425008020		4.25	0.8	20.0		2.5	15.6	13.0	27.46	6.2
C00425008025				25.0			19.3	16.0		4.8
C00425008032				32.0			24.9	20.8		3.9
C00425008040				40.0			31.2	26.0		3.1
C00425008050				50.0			38.7	32.0		2.4
C00425008063				63.0			48.8	40.5		1.9
C00426006006				6.3			4.3	3.1		7.8
C00426006008				8.0			5.5	4.0		6.3
C00426006010				10.0			6.8	5.0		4.9
C00426006013				12.5			8.5	6.2		3.9
C00426006016				16.0			11.0	8.0		3.1
C00426006020		4.26	0.63	20.0		2.8	13.7	10.0	15.69	2.5
C00426006025				25.0			17.0	12.5		2.0
C00426006032	LH			32.0			22.0	16.0		1.6
C00426006040				40.0			27.5	20.0		1.3
C00426006050				50.0			34.0	25.0		1.0
C00426006063				63.0			43.0	31.0		0.8
C00426006080				80.0			55.0	40.0		0.6
C00465010020				20.0			16.9	15.0		15.6
C00465010025		4.65	1	25.0	5.0	2.5	21.0	18.7	49.04	12.4
C00465010032				32.0			27.0	24.0		9.7

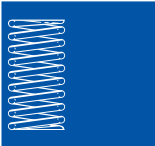

HIGH PERFORMANCE COMPRESSION SPRINGS

Part Number		Do (mm)	d (mm)	L (mm)	a (mm)	b (mm)	L ₁ (mm)	Sh (mm)	P ₁ (N)	R (N/mm)
C00465010040				40.0			33.7	30.0		7.8
C00465010050	LH	4.65	1	50.0		2.5	42.1	37.5	49.04	6.2
C00465010063				63.0			52.9	47.0		4.9
C00470007008				8.0			5.5	4.0		7.8
C00470007010				10.0			6.8	5.0		6.1
C00470007013				12.5			8.5	6.2		4.9
C00470007016				16.0			11.0	8.0		3.9
C00470007020				20.0			13.7	10.0		3.1
C00470007025	RH	4.70	0.7	25.0		3.2	17.0	12.5	19.61	2.5
C00470007032				32.0			22.0	16.0		2.0
C00470007040				40.0	5.0		27.5	20.0		1.6
C00470007050				50.0			34.0	25.0		1.2
C00470007063				63.0			43.0	31.0		1.0
C00470007080				80.0			55.0	40.0		0.8
C00470007100				100.0			68.0	50.0		0.6
C00480009020				20.0			15.6	13.0		8.0
C00480009025				25.0			19.3	16.0		6.2
C00480009032				32.0			24.9	20.8		5.0
C00480009040		4.80	0.9	40.0		2.8	31.2	26.0	35.31	4.0
C00480009050				50.0			38.7	32.0		3.1
C00480009063				63.0			48.8	40.5		2.5
C00480009080				80.0			62.4	52.0		2.0
C00494004013				12.5			6.2	2.5		0.5
C00494004016				16.0			8.0	3.2		0.4
C00494004020				20.0			10.0	4.0		0.3
C00494004025		4.94	0.4	25.0	5.2	4.0	12.5	5.0	3.14	0.3
C00494004032				32.0			16.0	6.4		0.2
C00494004040				40.0			20.0	8.0		0.2
C00494004050	LH			50.0			25.0	10.0		0.1
C00494004063				63.0			31.0	12.6		0.1
C00510007016				16.0			10.0	6.4		2.3
C00510007020				20.0			12.5	8.0		1.8
C00510007025				25.0			15.4	10.0		1.4
C00510007032				32.0			20.0	13.0		1.1
C00510007040		5.10	0.65	40.0	5.4	3.6	25.0	16.0	13.73	0.9
C00510007050				50.0			31.0	20.0		0.7
C00510007063				63.0			39.0	25.0		0.6
C00510007080				80.0			50.0	32.0		0.5
C00510007100				100.0			62.0	40.0		0.4
C00512011006				6.3			5.3	4.7		61.3
C00512011008				8.0			6.7	6.0		49.0
C00512011010				10.0			8.3	7.3		36.3
C00512011013				12.5			10.5	9.3		30.7
C00512011016				16.0			13.5	12.0		24.5
C00512011020		5.12	1.12	20.0	5.6	2.8	16.9	15.0	61.78	19.6
C00512011025				25.0			21.0	18.7		15.6
C00512011032				32.0			27.0	24.0		12.3
C00512011040				40.0			33.7	30.0		9.8
C00512011050				50.0			42.1	37.5		7.8
C00512011063				63.0			52.9	47.0		6.1
C00512011080				80.0			67.4	60.0		4.9
C00640008025				25.0			15.4	10.0		2.2
C00640008032				32.0			20.0	13.0		1.8
C00640008040				40.0			25.0	16.0		1.4
C00640008050		6.40	0.8	50.0	6.8	4.5	31.0	20.0	21.58	1.1
C00640008063				63.0			39.0	25.0		0.9
C00640008080				80.0			50.0	32.0		0.7
C00640008100				100.0			62.0	40.0		0.6
C00640008125				125.0			77.0	50.0		0.4
C00660014008				8.0			6.7	6.0		77.8
C00660014010	RH			10.0			8.3	7.3		57.7
C00660014013				12.5			10.5	9.3		48.7
C00660014016				16.0			13.5	12.0		38.9
C00660014020				20.0			16.9	15.0		31.1
C00660014025		6.60	1.4	25.0	7.0	3.6	21.0	18.7	98.07	24.7
C00660014032				32.0			27.0	24.0		19.5
C00660014040				40.0			33.7	30.0		15.6
C00660014050				50.0			42.1	37.5		12.5
C00660014063				63.0			52.9	47.0		9.7
C00660014080				80.0			67.4	60.0		7.8
C00670007010	LH	6.70	0.7	10.0		5.0	5.5	3.0	13.73	3.1

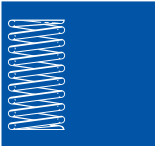

HIGH PERFORMANCE COMPRESSION SPRINGS

Part Number		Do (mm)	d (mm)	L (mm)	a (mm)	b (mm)	L ₁ (mm)	Sh (mm)	P ₁ (N)	R (N/mm)
C00670007013				12.5			6.9	4.5		2.5
C00670007016				16.0			9.0	4.8		2.0
C00670007020				20.0			11.0	6.0		1.5
C00670007025				25.0			13.8	7.0		1.2
C00670007032				32.0			18.0	9.5		1.0
C00670007040	LH	6.7	0.7	40.0	7.0	5.0	22.0	12.0	13.73	0.8
C00670007050				50.0			27.5	14.0		0.6
C00670007063				63.0			35.0	18.0		0.5
C00670007080				80.0			44.0	24.0		0.4
C00670007100				100.0			55.0	30.0		0.3
C00670007125				125.0			69.0	35.0		0.2
C00670007160				160.0			90.0	48.0		0.2
C00800010025				25.0			15.4	10.0		3.7
C00800010032				32.0			20.0	13.0		2.9
C00800010040				40.0			25.0	16.0		2.4
C00800010050	RH	8.00	1	50.0	8.4	5.6	31.0	20.0	35.31	1.9
C00800010063				63.0			39.0	25.0		1.5
C00800010080				80.0			50.0	32.0		1.2
C00800010100				100.0			62.0	40.0		0.9
C00800010125				125.0			77.0	50.0		0.7
C00850016016				16.0			12.5	10.4		31.1
C00850016020				20.0			15.6	13.0		24.9
C00850016025				25.0			19.3	16.0		19.4
C00850016032				32.0			24.9	20.8		15.6
C00850016040	LH	8.50	1.6	40.0	9.0	5.0	31.2	26.0	109.84	12.5
C00850016050				50.0			38.7	32.0		9.7
C00850016063				63.0			48.8	40.5		7.8
C00850016080				80.0			62.4	52.0		6.2
C00850016100				100.0			77.3	64.0		4.8
C00850016125				125.0			96.7	80.0		3.9
C00860009010				10.0			5.5	3.0		4.8
C00860009013				12.5			6.9	4.5		3.9
C00860009016				16.0			9.0	4.8		3.1
C00860009020				20.0			11.0	6.0		2.4
C00860009025				25.0			13.8	7.0		1.9
C00860009032				32.0			18.0	9.5		1.5
C00860009040		8.60	0.9	40.0		6.3	22.0	12.0	21.58	1.2
C00860009050				50.0			27.5	14.0		1.0
C00860009063				63.0			35.0	18.0		0.8
C00860009080				80.0			44.0	24.0		0.6
C00860009100				100.0			55.0	30.0		0.5
C00860009125	RH			125.0			69.0	35.0		0.4
C00860009160				160.0			90.0	48.0		0.3
C00860009200				200.0			110.0	60.0		0.2
C00860009250				250.0			138.0	70.0		0.2
C00865007025				25.0			12.5	5.0		0.8
C00865007032				32.0			16.0	6.4		0.6
C00865007040				40.0			20.0	8.0		0.5
C00865007050		8.65	0.7	50.0	9.1	7.0	25.0	10.0	9.81	0.4
C00865007063				63.0			31.0	12.6		0.3
C00865007080				80.0			40.0	16.0		0.2
C00865007100				100.0			50.0	20.0		0.2
C00865007125				125.0			62.0	25.0		0.2
C00990008025				25.0			12.5	5.0		1.0
C00990008032				32.0			16.0	6.4		0.8
C00990008040				40.0			20.0	8.0		0.6
C00990008050		9.90	0.8	50.0		8.0	25.0	10.0	12.26	0.5
C00990008063				63.0			31.0	12.6		0.4
C00990008080				80.0			40.0	16.0		0.3
C00990008100				100.0			50.0	20.0		0.2
C00990008125				125.0	10.5		62.0	25.0		0.2
C01000013032				32.0			20.0	13.0		4.6
C01000013040	LH			40.0			25.0	16.0		3.7
C01000013050				50.0			31.0	20.0		2.9
C01000013063		10.00	1.25	63.0		7.0	39.0	25.0		2.3
C01000013080				80.0			50.0	32.0	54.92	1.8
C01000013100				100.0			62.0	40.0		1.4
C01000013125				125.0			77.0	50.0		1.1
C01000013160				160.0			100.0	64.0		0.9
C01340014016		13.40	1.4	16.0	14.0	10.0	9.0	4.8		7.8
C01340014020				20.0			11.0	6.0		6.1

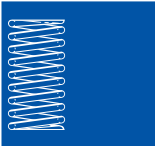

HIGH PERFORMANCE COMPRESSION SPRINGS

Part Number		Do (mm)	d (mm)	L (mm)	a (mm)	b (mm)	L ₁ (mm)	Sh (mm)	P ₁ (N)	R (N/mm)
C01340014025				25.0			13.8	7.0		4.9
C01340014032				32.0			18.0	9.5		3.9
C01340014040				40.0			22.0	12.0		3.1
C01340014050				50.0			27.5	14.0		2.4
C01340014063				63.0			35.0	18.0		2.0
C01340014080	LH	13.40	1.4	80.0	14.0	10.0	44.0	24.0	54.92	1.5
C01340014100				100.0			55.0	30.0		1.2
C01340014125				125.0			69.0	35.0		1.0
C01340014160				160.0			90.0	48.0		0.8
C01340014200				200.0			110.0	60.0		0.6
C01340014250				250.0			138.0	70.0		0.5
C01340014320				320.0			180.0	95.0		0.4
C01380011040				40.0			20.0	8.0		1.2
C01380011050				50.0			25.0	10.0		1.0
C01380011063				63.0			31.0	12.6		0.8
C01380011080	RH	13.80	1.1	80.0	14.6	11.2	40.0	16.0	24.52	0.6
C01380011100				100.0			50.0	20.0		0.5
C01380011125				125.0			62.0	25.0		0.4
C01380011160				160.0			80.0	32.0		0.3
C01380011200				200.0			100.0	40.0		0.2

